

PRODUCT DATA SHEET (ver. 02/02.2018)



1. Product

Air admittance valves **HypAir Balance** (MiniHab and MaxiHab)

2. Product overview

Air admittance valves respond to the negative air pressure created in a sewage system when sanitary facilities are used. Sewage flow can produce negative pressure and then water is drawn out of the siphons. Air admittance valves help to provide air supply to the sewage system and thus compensate for negative air pressure. Class A air admittance valves can also be installed below the flooding level, e.g. in basements.

3. Technical specifications

Technical data	Diameter Ø [mm]				
	70-110	110	32-63	50	40/50
High [mm]	108	105	80	78	78
Material	ABS	ABS	ABS	ABS	ABS
Weight [kg]	0,19	0,3	0,11	0,07	0,9
Color	white/gray/black	white/gray/black	White	White	white
Air flow [l/s]	23,2	25,4	6,1	7,6	7,3
Class (PN-EN 12380)	A I				
Temperature [°C]	-20 to +60				

4. Dimensions



MaxiHab 70-110

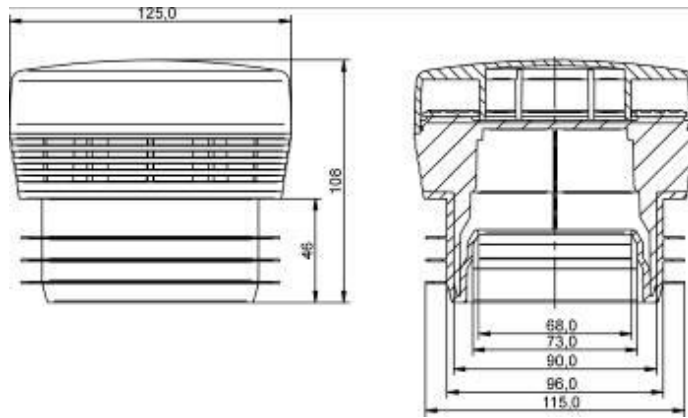

MaxiHab 110

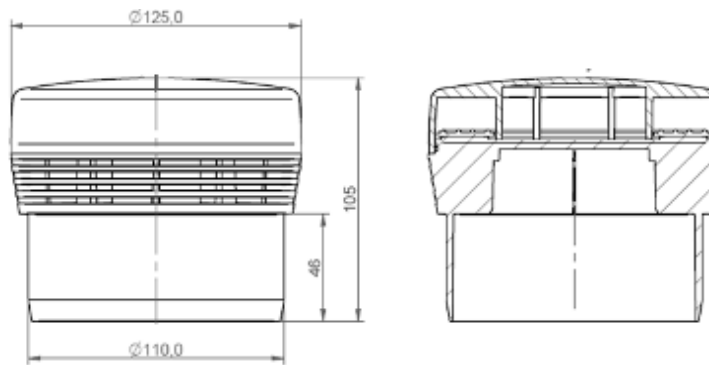

MiniHab 32-63

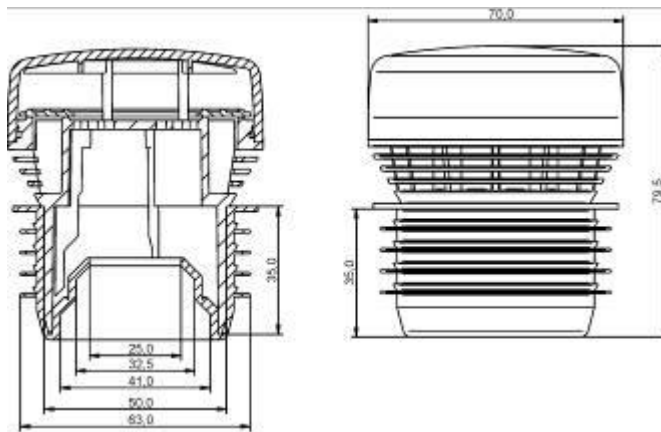

MiniHab Ø 50; Ø40/50

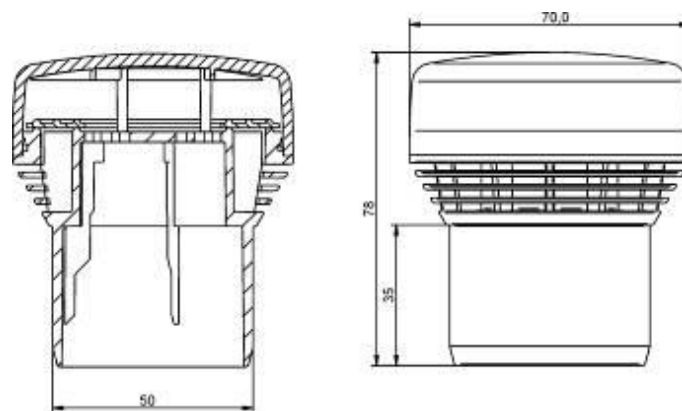

5. Product codes

Code	Model	Color	Dimension [mm]
9-2730-070-10-03-01	MaxiHab	white	70, 75, 90, 110
9-2730-070-10-03-03	MaxiHab	gray	70, 75, 90, 110
9-2730-070-10-03-10	MaxiHab	black	70, 75, 90, 110
9-2731-110-00-03-01	MaxiHab	white	110
9-2731-110-00-03-03	MaxiHab	gray	110
9-2731-110-00-03-10	MaxiHab	black	110
9-2730-030-63-03-01	MiniHab	white	32, 40, 50, 63
9-2731-050-00-03-01	MiniHab	white	50
9-2732-050-00-03-01	MiniHab	white	40, 50

6. Design and material

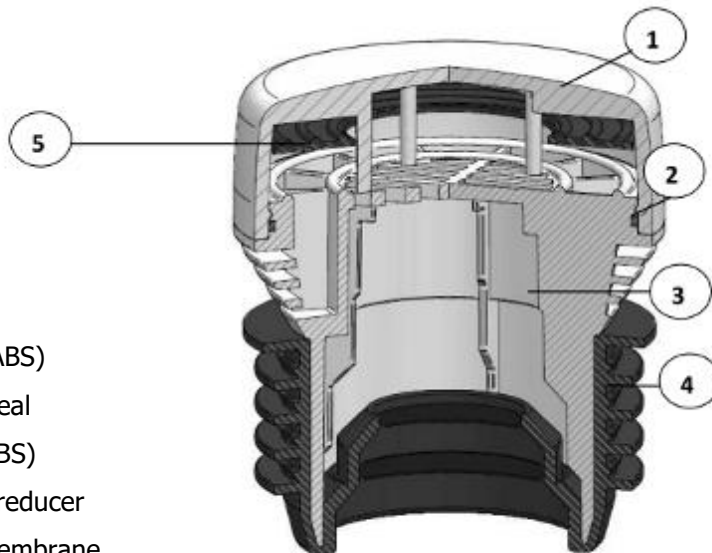

1. Cover (ABS)
2. O-ring seal
3. Body (ABS)
4. Rubber reducer
5. Valve/Membrane

7. Working principle

The product provides air supply and helps to compensate negative pressure. When negative pressure is created in the system, the resulting suction power raises the membrane in the valve and thus admits air into the system. As a result negative pressure is fully compensated.

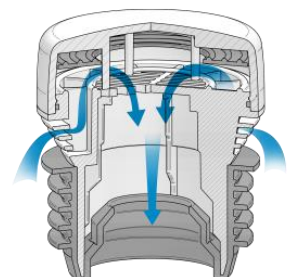

Air admittance valves help to prevent the spread of sewer gases (unpleasant odours) to outside the pipeline – the valve closes as soon as the membrane falls, thus preventing the diffusion of odours.

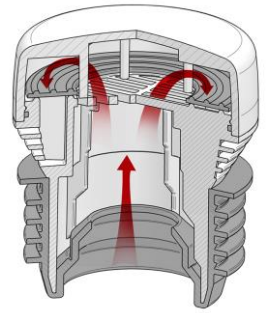

8. Air admittance valve selection

To select an appropriate air admittance valve, the level of air supply required for a given sewage system must be determined. The respective guidelines are outlined in national standards and regulations.

The most suitable air admittance valve is chosen based on the calculated total waste water flow rate (l/s) and the required air supply level.

9. Installation

- Installation: **HypAir Balance** MaxiHab Ø70-110
Product code: **9-2730-070-10-03-01**

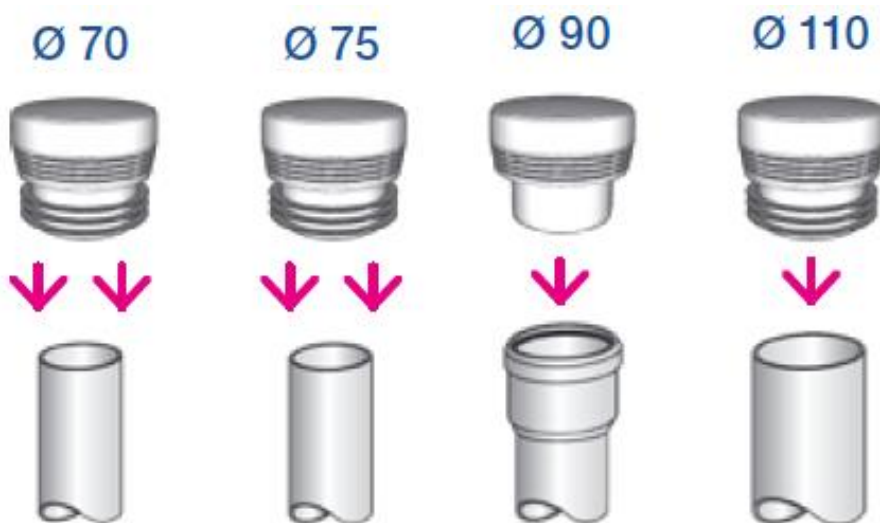

- Installation: **HypAir Balance** MaxiHab Ø110
Product code: **9-2731-110-00-03-01**



- Installation: **HypAir Balance** MiniHab Ø32-63
Product code: **9-2730-030-63-03-01**



- Installation: **HypAir Balance** MiniHab Ø50
Product code: **9-2731-050-00-03-01**

Ø 50



- Installation: **HypAir Balance** MiniHab Ø40/50
Product code: **9-2732-050-00-03-01**

Ø 50

Ø 40

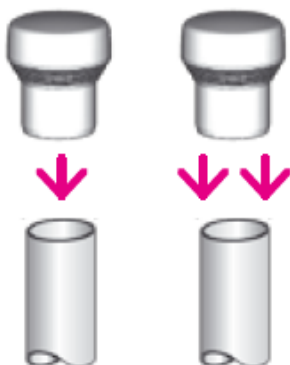

10. Logistics

Code	Bulk package			Pallet 2,0 m		
	Quantity [pcs./ package.]	Dimensions. [mm]	Weight [kg]	Quantity [pcs./ pallet]	Quantity of bulk packages	Pallet weight [kg]
9-2730-070-10-03-01	27	385x385x345	5,13	675	25	128,25
9-2730-070-10-03-03	27	385x385x345	5,13	675	25	128,25
9-2730-070-10-03-10	27	385x385x345	5,13	675	25	128,25
9-2731-110-00-03-01	27	385x385x345	8,1	675	25	202,5
9-2731-110-00-03-03	27	385x385x345	8,1	675	25	202,5
9-2731-110-00-03-10	27	385x385x345	8,1	675	25	202,5
9-2730-030-63-03-01	96	485x335x360	10,56	2400	25	264
9-2731-050-00-03-01	96	485x335x360	6,72	2400	25	168
9-2732-050-00-03-01	96	485x335x360	86,4	2400	25	2160

11. Packaging



11. Standards and certificates

- PN-EN 12380:2005
- PN-EN ISO 3126:2006



13. Advantages

- reduced investment costs.
- a single product which is suitable for installation on pipes of different sizes.
- air admittance valves prevent the spread of bad odours from a sewage system.
- in the event of a fire, the valves reduce the risk of fire and smoke spreading via sewage pipes (through the elimination of the stack effect).
- they provide designers, architects and engineers support when designing sewage systems and sanitary facilities.

12. Warranty and liability

During the installation it is required to observe OHS rules included in building regulations and norms. Capricorn S.A. More information about warranty and extent of liability on www.capricorn.pl/en

13. Manufacturer

Capricorn S.A.

58-160 Świebodzice,

Ciernie 11

tel./fax +48/74/854 05 16

www.capricorn.pl/en

e-mail: capricorn@capricorn.pl