

ISO TUBI

TUBOS Y ACCESORIOS
DE ACERO INOXIDABLE



CATÁLOGO DE PRODUCTO
TUBOS Y ACCESORIOS PRENSADOS DE ACERO INOXIDABLE

PRODUCT CATALOGUE
STAINLESS STEEL TUBES AND FITTINGS

WWW.ISOTUBI.COM

INTRODUCCIÓN ♦ INTRODUCTION	04
CERTIFICADOS ♦ CERTIFICATES	06
FIG.1 MANGUITO ♦ COUPLING	12
FIG.2 MANGUITO DE ALARGO ♦ SLIP COUPLING	12
FIG.3 CODO 90° H-H ♦ 90° F-F ELBOW	12
FIG.4 CODO 90° H-M ♦ 90° M-F ELBOW	13
FIG.5 CODO 45° H-H ♦ 45° F-F ELBOW	13
FIG.6 CODO 45° H-M ♦ 45° M-F ELBOW	13
FIG.7 CODO HEMBRA ROSCA HEMBRA ♦ FEMALE ANGLE ADAPTOR	14
FIG.8 CODO HEMBRA ROSCA MACHO ♦ MALE ANGLE ADAPTOR	14
FIG.9 CODO PLACA ♦ F ELBOW WITH WALLNUT	14
FIG.10 CODO DE AJUSTE 90° ♦ 90° ELBOW WITH PLANE ENDS	15
FIG.11 MANGUITO CON TUERCA LOCA ♦ VALVE CONECT. WITH SWIVEL IN STAINLESS	15
FIG.12 TE SALIDA CENTRAL ROSCA ♦ F TEE THREADED ADAPTOR	16
FIG.14 REDUCCIÓN ♦ MF REDUCER	16
FIG.15 TE SALIDA CENTRAL REDUCIDA ♦ REDUCING TEE	17
FIG.16 TE IGUAL ♦ EQUAL TEE	18
FIG.17 ENTRONQUE HEMBRA ♦ FEMALE ADAPTOR	18
FIG.18 ENTRONQUE MACHO ♦ MALE ADAPTOR	19
FIG.19 BRIDA ADAPTADOR ♦ FLANGES ADAPTOR	19
FIG.20 CURVA DESVÍO ♦ PRE-FORMED PIPE BRIDGE	20
FIG.21 TAPÓN ♦ PLUG	20
FIG.22 BAJANTE DESVÍO DOBLE ♦ AIR TUBE PIPE BRIDGE	20
FIG.23 CURVA DESVÍO DOBLE ♦ PIPE BRIDGE	21
FIG.24 UNIÓN 3 PZS ♦ 3 PCS ADAPTOR	21
FIG.25 CURVA DESVÍO DOBLE 1/2 MANGUITO ♦ FF PIPE BRIDGE	21
FIG.26 CONECTOR HEMBRA ♦ FEMALE CONNECTOR	22
FIG.27 CONECTOR MACHO ♦ MALE CONNECTOR	22
FIG.28 BRIDA LOCA ADAPTADOR ♦ PRESS FLANGED ADAPTOR	22
FIG.29 TUBERÍA METÁLICA FLEXIBLE ♦ FLEXIBLE TUBES	23
FIG.30 CRUZ IGUAL O REDUCIDA ♦ EQUAL OR REDUCED CROSS	23
FIG.31 VÁLVULA DE BOLA 3 PZS ♦ 3 PCS SS BALL VALVE PRESS X PRESS	23
FIG.32 VÁLVULA DE BOLA 2 PZS ♦ 2 PCS SS BALL VALVE FULL PORT	24
FIG.33 CODO 45° ROSCA MACHO ♦ 45° MALE ANGLE ADAPTOR	24
FIG.34 CODO 90° ROSCA HEMBRA ♦ 90° FEMALE ANGLE ADAPTOR	24
FIG.35 CODO 90° H TUERCA LOCA ♦ 90° F ANGLE ADAPTOR WITH SWIVEL NUT	25

FIG.36 TE SALIDA CENTRAL ROSCA MACHO ♦ MALE TEE THREADED ADAPTOR	25
FIG.37 CRUZ ROSCADA MACHO ♦ MALE THREADED CROSS	25
FIG.38 CRUZ ROSCADA HEMBRA ♦ FEMALE THREADED CROSS	26
FIG.39 CODO 90° H ROSCA MACHO ♦ 90° MALE ANGLE ADAPTOR	26
FIG.41 TUERCA MACHO 3 PZS ♦ MALE UNION CONNECTOR GAS	26
FIG.42 TUERCA HEMBRA 3 PZS ♦ FEMALE UNION CONNECTOR GAS	27
FIG.45 TUERCA HEMBRA 2 PZS ♦ UNION GAS FEMALE THREADED	27
FIG.46 RACORD 3 PZS EUROPEO ♦ STRAIGHT UNION WITH PRESSFITTING ON BOTH ENDS	27
FIG.47 MEDIO MANGUITO ♦ HALF COUPLING	28
FIG.48 CODO 30° HEMBRA-HEMBRA ♦ 30° FEMALE-FEMALE F ELBOW	28
FIG.49 CODO DE AJUSTE 30° ♦ 30° ELBOW WITH PLAIN ENDS	28
FIG.50 CODO 15° HEMBRA-HEMBRA ♦ 15° FEMALE-FEMALE ELBOW	29
FIG.51 CODO 60° HEMBRA-HEMBRA ♦ 60° FEMALE-FEMALE ELBOW	29
FIG.52 BRIDA ADAPTADOR PN6 ♦ FLANGES ADAPTOR PN6	29
FIG.53 PASA CUBIERTA CON CAMISA DE FE ♦ PIPE PENETRATION	30
FIG.54 TAPÓN MACHO ♦ MALE PLUG	30
FIG.55 ADAPTADOR PARA SOLDAR ♦ WELD ADAPTOR	30
FIG.56 CODO 75° HEMBRA-HEMBRA ♦ 75° FEMALE-FEMALE ELBOW	31
FIG.57 CODO 10° HEMBRA-HEMBRA ♦ 10° FEMALE-FEMALE ELBOW	31
FIG.58 CODO DE AJUSTE 60° ♦ 60° ELBOW WITH PLAIN ENDS	31
FIG.59 CODO DE AJUSTE 15° ♦ 15° ELBOW WITH PLAIN ENDS	32
FIG.61 MANGUITO CON TUBO RANURADO ♦ TRANSITION FOR GROOVED COUPLING	32
FIG.63 CODO DE AJUSTE 75° ♦ 75° ELBOW WITH PLAIN ENDS	32
FIG.64 CODO 15° MACHO-HEMBRA ♦ 15° MALE-FEMALE ELBOW	33
FIG.65 PASA CUBIERTA M-H ♦ M-F PIPE PENETRATION	33
FIG.66 CODO 30° MACHO-HEMBRA ♦ 30° MALE-FEMALE ELBOW	33
FIG.71 COMPENSADOR DILATACIÓN ♦ ELONGATION COMPENSATOR	34
FIG.72 CODO DE AJUSTE 45° ♦ 45° ELBOW PLAIN ENDS	34
FIG.73 CODO DE AJUSTE 10° ♦ 10° ELBOW PLAIN ENDS	34
FIG.76 CODO PLACA DOBLE ♦ F DOUBLE ELBOW WITH WALLNUT	35
JUNTAS EPDM ♦ EPDM O-RING	35
JUNTAS FKM ♦ FKM O-RING	35
TUBO SOLDADO ♦ WELDED TUBES	36
PRINCIPALES MÁQUINAS DE PRENSADO ♦ MAIN PRESSFITTING TOOLS	38
CONDICIONES GENERALES DE VENTA ♦ GENERAL SALES TERMS	40

En Isotubi, S.L., perteneciente al **Grupo Lapuente**, fabricamos tubería soldada y accesorios de acero inoxidable desde hace más de 25 años. Plenamente consolidados en el mercado europeo, ofrecemos a nuestros clientes un producto capaz de alcanzar las más altas exigencias de calidad de las principales normas internacionales.

El conocimiento de las necesidades de nuestros clientes, una voluntad constante de adaptación a las nuevas tecnologías y un esfuerzo continuo en mejorar el servicio al cliente son los objetivos de nuestro equipo humano.

Nuestros procesos productivos y el sistema de calidad, certificado por TÜV de acuerdo a la norma internacional ISO 9001 avalan la calidad y fiabilidad de nuestros productos. También disponemos de los principales certificados de calidad europeos: AD Merkblatt, Directiva 97/23/CE para equipos a presión, CERTIF, DVGW, DNV, LLOYDS, WATERMARK, CSIRO, SITAC, NSF, FM, WRAS, STO, ABS y certificado TÜV de producto **NUMEPRESS**.

Y todo ello gracias a nuestro equipo humano, en el que se unen experiencia y juventud, y en el que la ilusión por mejorar, el esfuerzo y el trabajo diario constituyen nuestra base de trabajo.

NUESTRO PRODUCTO NUMEPRESS

Les presentamos en este catálogo nuestra gama de productos **NUMEPRESS**, sistema de tubería y accesorios para prensar en acero inoxidable, que permite, de un modo fácil y rápido, realizar instalaciones sin roscas y sin soldaduras y con un considerable ahorro de tiempo y mano de obra.

Nuestra fábrica y nuestro almacén, con un stock importante a su disposición, nos permite satisfacer de un modo rápido las necesidades del cliente, ya sean en la gama estándar de productos, o en aquellos fabricados a medida.

Las principales aplicaciones de nuestro producto permiten cubrir una amplia gama de sectores: **aire comprimido, calefacción, climatización, sistemas contraincendios, energía solar, agua potable, industria, naval y minería.**



*Isotubi, S.L., is part of **Grupo Lapuente**, has been working in the stainless steel world for more than 25 years. As a result of this experience our company is able to offer a competitive product which meets the most important quality requirements in the international markets.*

Our main challenges are to know about the concrete needs of our customers, to adapt our products and processes to the new technologies and to make a constant effort in improving our customer service. Both our production and quality control processes are certified by Tüv according to the ISO 9001 norm. We also hold the main European Approvals for our products and processes: AD Merkblatt (Germany), 97/23/CE Pressure Equipments Directive, CERTIF (Portugal), DVGW (Germany), Numepress TÜV product certificate (Spain and Portugal), LLOYDS, WATERMARK, SITAC, CSIRO, NSF, FM, WRAS, STO, ABS and DNV Approval for ships.

NUMEPRESS SYSTEM

We are presenting in this catalogue our range of NUMEPRESS products, the stainless steel tube and Pressfitting system which allows making facilities in a very easy way, without using welding or threads, saving a considerable amount of time and money.

Our factory and warehouse, located in Barcelona, has an important stock at our customer's disposal, so delivery terms are extremely short. As we are manufacturers, we can also offer specialized products to our customers when needed.

*These are the main applications of our system: **compressed air, heating facilities, sanitation facilities, fire-extinguishing system (sprinkler), solar energy, plumbing, industrial facilities, shipping facilities and mining.***

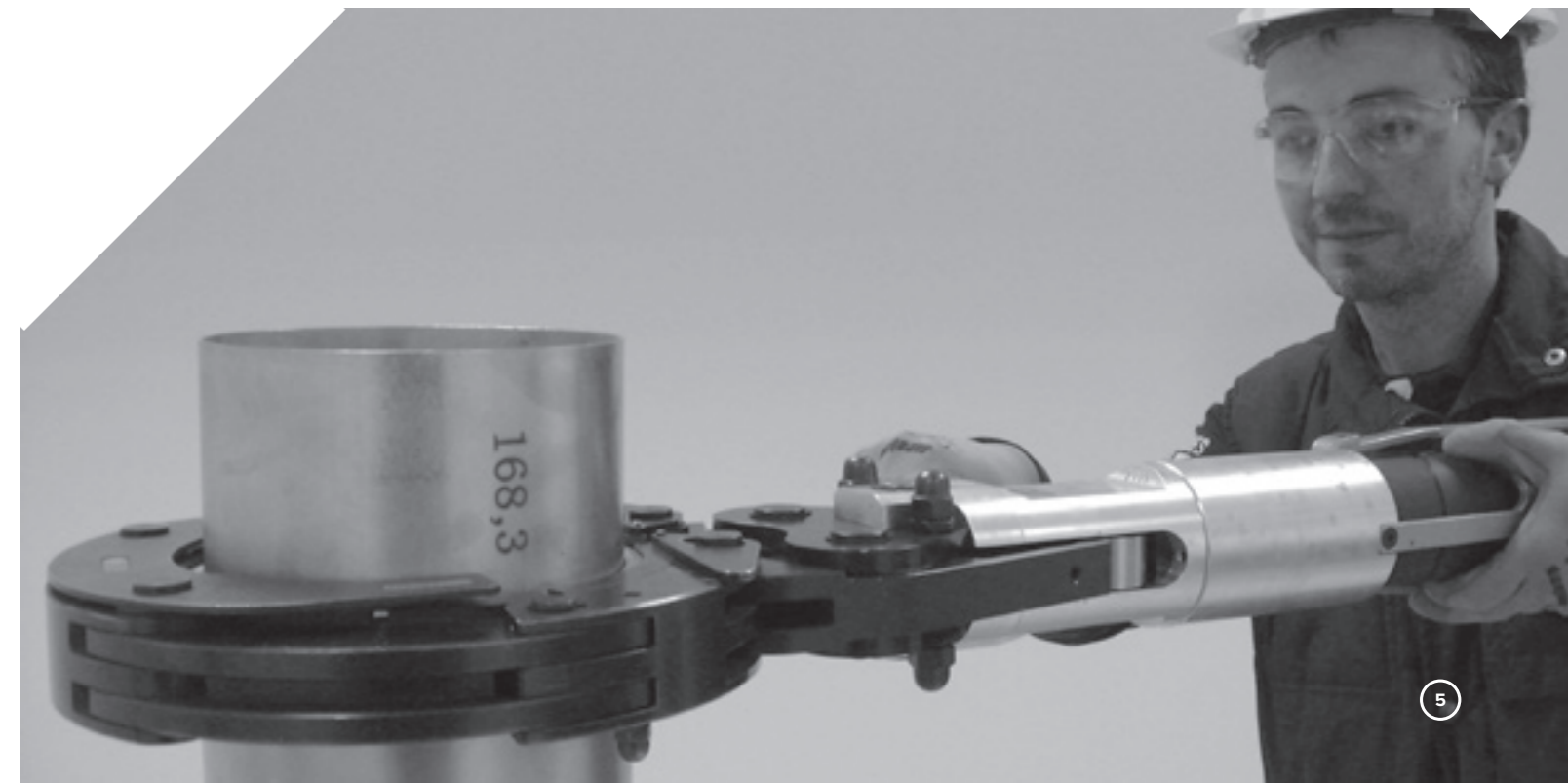

**CERTIFICADOS
CERTIFICATES**



**CERTIFICADOS
CERTIFICATES**

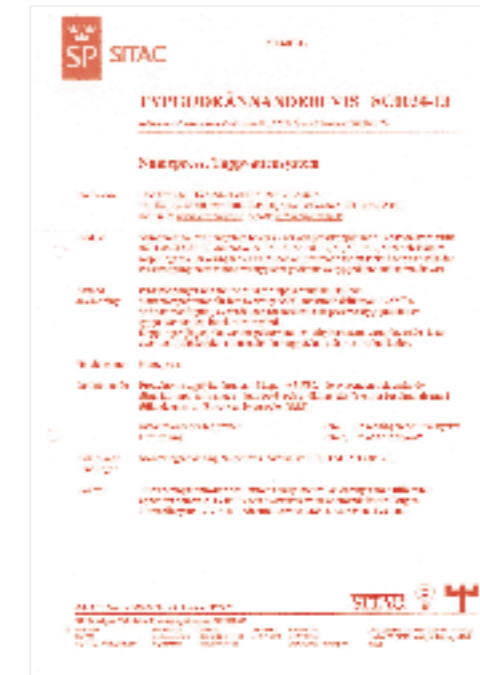

CERTIFICADOS CERTIFICATES



➤ Desde diámetro 12 a 108 ◆ From diameter 12 to 108



➤ Solo los productos que llevan la marca NSF en el producto, el embalaje del producto y/o documentación que se envía con el producto están certificados.
Only products bearing the NSF Mark on the product, product packaging, and/or documentation shipped with the product are Certified.

FIG.1



MAT: AISI 316L

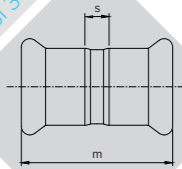

FIG.2



MAT: AISI 316L

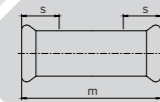
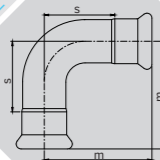

FIG.3



MAT: AISI 316L



MANGUITO
COUPLING

Dimensiones Dimensions	m	s	Nº piezas/Bolsas Nº pieces/Bag
10	31,5	7	20
NSF 12	42	6	20
NSF 15	49	8	20
NSF 18	50	8	20
NSF 22	50,5	8	20
◀ FM ▶ NSF 28	55	8	20
◀ FM ▶ NSF 35	70	18	10
◀ FM ▶ NSF 42	78	18	4
◀ FM ▶ NSF 54	85,5	18	4
◀ FM ▶ NSF 76,1	140,5	33	1
◀ FM ▶ NSF 88,9	160	45	1
◀ FM ▶ NSF 108	197	58	1
NSF 114,3	193	51	1
NSF 139,7	250	54	1
NSF 168,3	300	64	1

CODO 90° H-M
90° M-F ELBOW

Dimensiones Dimensions	m	h	s	Nº piezas/Bolsas Nº pieces/Bag
10	28,5	36	16	20
NSF 12	43	50	27	20
NSF 15	48	67	28	20
NSF 18	52	65	32	20
NSF 22	61	74	40	20
◀ FM ▶ NSF 28	71,5	82	49	10
◀ FM ▶ NSF 35	74	85	48	10
◀ FM ▶ NSF 42	86	96,5	56	4
◀ FM ▶ NSF 54	105	122	71,5	2
◀ FM ▶ NSF 76,1	177	195	123,5	1
◀ FM ▶ NSF 88,9	181	202	123	1
◀ FM ▶ NSF 108	214	240	140	1
NSF 114,3	250	253	179	1
NSF 139,7	314	322	216	1
NSF 168,3	386	404	268	1

FIG.4



MAT: AISI 316L

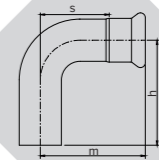

MANGUITO DE ALARGO
SLIP COUPLING

Dimensiones Dimensions	m	s	Nº piezas/Bolsas Nº pieces/Bag
12	56,5	16	20
15	80	27,5	20
18	80	27,5	20
22	71	19,5	20
◀ FM ▶ 28	84	22	20
◀ FM ▶ 35	99	26	10
◀ FM ▶ 42	114	30	4
◀ FM ▶ 54	136	34	4
◀ FM ▶ 76,1	226	54	1
◀ FM ▶ 88,9	255	58	1
◀ FM ▶ 108	300	71,5	1

CODO 45° H-H
45° F-F ELBOW

Dimensiones Dimensions	m	s	Nº piezas/Bolsas Nº pieces/Bag
12	32	16	20
15	34,5	14,5	20
18	36	16	20
22	41	20	20
◀ FM ▶ 28	46	24	10
◀ FM ▶ 35	54,5	28,5	10
◀ FM ▶ 42	67,5	37,5	4
◀ FM ▶ 54	66,5	33	2
◀ FM ▶ 76,1	111	57,5	1
◀ FM ▶ 88,9	114	56	1
◀ FM ▶ 108	138	64	1
114,3	161	89	1
139,7	203	105	1
168,3	252	134	1

FIG.5



MAT: AISI 316L

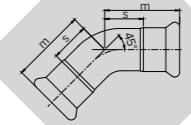

CODO 90° H-H
90° F-F ELBOW

Dimensiones Dimensions	m	s	Nº piezas/Bolsas Nº pieces/Bag
10	28,5	16	20
NSF 12	43	27	20
NSF 15	48	28	20
NSF 18	52	32	20
NSF 22	61	40	20
◀ FM ▶ NSF 28	71,5	49	10
◀ FM ▶ NSF 35	74	48	10
◀ FM ▶ NSF 42	86	56	4
◀ FM ▶ NSF 54	105,5	71,5	2
◀ FM ▶ NSF 76,1	177	123,5	1
◀ FM ▶ NSF 88,9	181	123	1
◀ FM ▶ NSF 108	214	140	1
NSF 114,3	250	179	1
NSF 139,7	314	216	1
NSF 168,3	386	268	1

CODO 45° H-M
45° M-F ELBOW

Dimensiones Dimensions	m	h	s	Nº piezas/Bolsas Nº pieces/Bag
12	32	45	16	20
15	34,5	47	14,5	20
18	36	48,5	16	20
22	40	52	20	20
◀ FM ▶ 28	46	58	24	10
◀ FM ▶ 35	54,5	69	28,5	10
◀ FM ▶ 42	67,5	77,5	37,5	4
◀ FM ▶ 54	66,5	84	33	2
◀ FM ▶ 76,1	111	128	57,5	1
◀ FM ▶ 88,9	114	135	56	1
◀ FM ▶ 108	138	169	64	1
114,3	161	164	89	1
139,7	203	210	105	1
168,3	252	253	134	1

FIG.6



MAT: AISI 316L

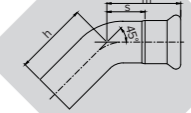
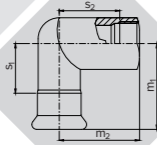

FIG.7



MAT: AISI 316L



CODO HEMBRA ROSCA HEMBRA
FEMALE ANGLE ADAPTOR

NSF

Dimensiones Dimensions	m ₁	m ₂	s ₁	s ₂	Nº piezas/Bolsas Nº pieces/Bag
12-Rp 1/2"	55	37	37	24	20
15-Rp 1/2"	57	37	37	24	20
18-Rp 1/2"	57	39	37	26	20
18-Rp 3/4"	59	46	39	31	10
22-Rp 3/4"	59	46	39	31	10
◀ FM ▶ 28-Rp 1"	67	54	44	37	10
◀ FM ▶ 35-Rp 1 1/4"	75	63	49	44	10

NSF

CODO DE AJUSTE 90°
90° ELBOW WITH PLANE ENDS

Dimensiones Dimensions	h ₁	h _{1min.}	h ₂	h _{2min.}	Nº piezas/Bolsas Nº pieces/Bag
12	60	50	70	60	20
15	70	58	120	58	20
18	70	63	120	63	20
22	70	70	120	70	10
◀ FM ▶ 28	80	80	120	80	10
◀ FM ▶ 35	120	100	200	100	4
◀ FM ▶ 42	150	120	250	120	2
◀ FM ▶ 54	200	145	300	145	2
76,1	195	-	195	-	1
88,9	202	-	202	-	1
108	240	-	240	-	1

FIG.10



MAT: AISI 316L

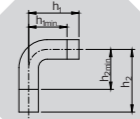
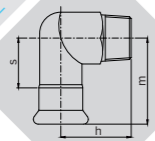

FIG.8



MAT: AISI 316L



CODO HEMBRA ROSCA MACHO
MALE ANGLE ADAPTOR

NSF

Dimensiones Dimensions	m	h	s	Nº piezas/Bolsas Nº pieces/Bag
12-R 1/2"	55	37	37	20
15-R 1/2"	57	37	37	20
18-R 1/2"	57	39	37	20
18-R 3/4"	59	46	39	10
22-R 3/4"	59	46	39	10
◀ FM ▶ 28-R 1"	67	54	44	10
◀ FM ▶ 35-R 1 1/4"	75	63	49	10
◀ FM ▶ 42-R 1 1/2"	84	67	54	2
◀ FM ▶ 54-R 2"	93	78	60	2

NSF

MANGUITO CON TUERCA LOCA
VALVE CONECT. WITH SWIVEL IN STAINLESS

Dimensiones Dimensions	m	s	Nº piezas/Bolsas Nº pieces/Bag
15-Rp 1/2"	63,5	37,5	10
18-Rp 1/2"	62	37	10
18-Rp 3/4"	61	38	10
22-Rp 3/4"	62	39,5	10
◀ FM ▶ 28-Rp 1"	69,5	43,5	10
◀ FM ▶ 35-Rp 1 1/4"	76	42	4
◀ FM ▶ 42-Rp 1 1/2"	82,5	46	4
◀ FM ▶ 54-Rp 2"	88	50	4
◀ FM ▶ 54-Rp 2 1/2"	105	52,5	1
◀ FM ▶ 76,1-Rp 2 1/2"	185,5	113	1

FIG.11



MAT: AISI 316L

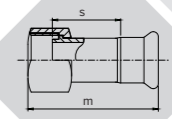
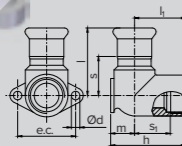

FIG.9



MAT: AISI 316L



CODO PLACA
F ELBOW WITH WALLNUT

NSF

Dimensiones Dimensions	m	h	l ₁	l	Ød	e.c.	s	s ₁	Nº piezas/Bolsas Nº pieces/Bag
NW-12-Rp 1/2"	14	44	30	48	5	34	28	17	20
NW-15-Rp 1/2"	14	44	30	50	5	34	28	17	20
NW-18-Rp 1/2"	14	44	30	50	5	34	30	17	20
NW-22-Rp 3/4"	18	51	34	54	6	40	33	20	20

FIG.12



MAT: AISI 316L

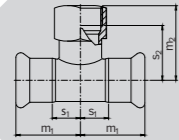

TE SALIDA CENTRAL ROSCA
F TEE THREADED ADAPTOR

	Dimensiones Dimensions	m ₁	m ₂	s ₁	s ₂	Nº piezas/Bolsas Nº piezas/Bag
NSF	10-Rp 3/8"-10	29	28	18	19	20
NSF	12-Rp 3/8"-12	28,3	27	12,3	18	20
NSF	15-Rp 1/2"-15	32	36	12	23	20
NSF	18-Rp 1/2"-18	34	37	14	24	20
NSF	18-Rp 3/4"-18	34	41	14	26	20
NSF	22-Rp 1/2"-22	35,5	39	16	26	20
NSF	22-Rp 3/4"-22	35,5	44	16	29	20
◀ FM ▶ NSF	28-Rp 1/2"-28	41	42	19	29	10
◀ FM ▶ NSF	28-Rp 3/4"-28	41	46	19	31	10
◀ FM ▶ NSF	28-Rp 1"-28	41	47	19	30	10
◀ FM ▶ NSF	35-Rp 1/2"-35	50	45	24	32	10
◀ FM ▶ NSF	35-Rp 3/4"-35	50	50	24	35	10
◀ FM ▶ NSF	35-Rp 1"-35	50	51	24	34	10
◀ FM ▶ NSF	35-Rp 1 1/4"-35	50	55	24	36	10
◀ FM ▶ NSF	42-Rp 1/2"-42	57	48	27	35	4
◀ FM ▶ NSF	42-Rp 3/4"-42	57	52	27	37	4
◀ FM ▶ NSF	42-Rp 1"-42	57	53	27	34	4
◀ FM ▶ NSF	42-Rp 1 1/2"-42	57	61	27	42	4
◀ FM ▶ NSF	54-Rp 1/2"-54	68	55	34	41	2
◀ FM ▶ NSF	54-Rp 3/4"-54	68	58	34	43	2
◀ FM ▶ NSF	54-Rp 1"-54	68	59	34	41	2
◀ FM ▶ NSF	54-Rp 2"-54	68	76	34	47	2
◀ FM ▶ NSF	76,1-Rp 3/4"-76,1	113	71	59	56	1
◀ FM ▶ NSF	76,1-Rp 2"-76,1	113	91	59	62	1
◀ FM ▶ NSF	88,9-Rp 3/4"-88,9	128	78	70	63	1
◀ FM ▶ NSF	88,9-Rp 2"-88,9	128	97	70	68	1
◀ FM ▶ NSF	108-Rp 3/4"-108	150	87	81	72	1
◀ FM ▶ NSF	108-Rp 2"-108	150	107	81	78	1

REDUCCIÓN
MF REDUCER

	Dim. Dim.	m	s	Nº piezas/Bolsas Nº piezas/Bag	Dim. Dim.	m	s	Nº piezas/Bolsas Nº piezas/Bag
	15-12	50	34	20	54-35	101	75	4
	18-12	55	39	20	54-42	101	71	4
	22-12	52	36	20	76,1-22	120	100,5	1
	18-15	62	42	20	76,1-28	123	101	1
	22-15	64	44	20	76,1-35	126	100	1
	22-18	60	40	20	76,1-42	130	100	1
	28-15	68	48	20	76,1-54	132	98	1
	28-18	66	46	20	88,9-42	159	129	1
	28-22	65	45,5	20	88,9-54	162	128	1
	35-15	77	57	10	88,9-76,1	179	126	1
	35-18	77	57	10	108-54	179	145	1
	35-22	81	61,5	10	108-76,1	198	145	1
◀ FM ▶	35-28	74	52	10	108-88,9	206	148	1
	42-15	85	65	4	114,3-88,9	282	225	1
	42-18	87	67	4	114,3-76,1	272	218	1
	42-22	86	66,5	4	139,7-88,9	340	282	1
◀ FM ▶	42-28	82	60	4	139,7-108	307	236	1
◀ FM ▶	42-35	88	62	4	139,7-114,3	357	286	1
	54-15	92	72	4	168,3-88,9	379	321	1
	54-18	93	73	4	168,3-108	360	289	1
	54-22	92	72,5	4	168,3-114,3	394	323	1
◀ FM ▶	54-28	93	71	4	168,3-139,7	422	324	1

FIG.14



MAT: AISI 316L

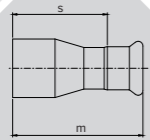

NSF

TE SALIDA CENTRAL REDUCIDA
REDUCING TEE

	Dimensiones Dimensions	m ₁	m ₂	s ₁	s ₂	Nº piezas/Bolsas Nº piezas/Bag
	15-12-15	32	35	12	19	20
	18-12-18	34	37	14	21	20
	22-12-22	35,5	42	16	26	20
	18-15-18	34	40	14	20	20
	22-15-22	35,5	42	16	22	20
	22-18-22	35,5	42	16	22	20
	28-15-28	41	45	19	25	10
	28-18-28	41	45	19	25	10
	28-22-28	41	45	19	25	10
	35-15-35	50	48	24	28	10
	35-18-35	50	48	24	28	10
	35-22-35	50	48	24	28	10
◀ FM ▶	35-28-35	50	51	24	28	10
	42-15-42	57	51,5	27	31,5	4
	42-18-42	57	52	27	31	4
	42-22-42	57	51	27	31	4
◀ FM ▶	42-28-42	57	53	27	31	4
◀ FM ▶	42-35-42	57	57	27	31	4
	54-15-54	68	56,5	34	37,5	2
	54-18-54	68	56,5	34	37,5	2
	54-22-54	68	57	34	37,5	2
◀ FM ▶	54-28-54	68	60	34	38	2
◀ FM ▶	54-35-54	68	63	34	37	2
◀ FM ▶	54-42-54	68	67	34	37	2
	76,1-22-76,1	113	68	59	48	1
◀ FM ▶	76,1-28-76,1	113	72	59	49	1
◀ FM ▶	76,1-35-76,1	113	74	59	48	1
◀ FM ▶	76,1-42-76,1	113	76	59	46	1
◀ FM ▶	76,1-54-76,1	113	83	59	46,7	1
	88,9-22-88,9	128	75	72	55	1
◀ FM ▶	88,9-28-88,9	128	79	72	56	1
◀ FM ▶	88,9-35-88,9	128	81	72	55	1
◀ FM ▶	88,9-42-88,9	128	83	72	53	1
◀ FM ▶	88,9-54-88,9	128	90	72	53,7	1
◀ FM ▶	88,9-76,1-88,9	128	115	72	63	1
	108-22-108	150	84	81	64	1
◀ FM ▶	108-28-108	150	88	81	65	1
◀ FM ▶	108-35-108	150	90	81	64	1
◀ FM ▶	108-42-108	150	95	81	65	1
◀ FM ▶	108-54-108	150	99	81	65	1
◀ FM ▶	108-76,1-108	150	126,5	81	73	1
◀ FM ▶	108-88,9-108	150	136	81	74	1
	114,3-76,1-114,3	155	130	83	75	1
	114,3-88,9-114,3	155	140	83	82	1
	139,7-76,1-139,7	197	143	99	88	1
	139,7-88,9-139,7	197	153	99	95	1
	139,7-108-139,7	197	167	99	96	1
	139,7-114,3-139,7	197	170	99	98	1
	168,3-76,1-168,3	257	157	139	103	1
	168,3-88,9-168,3	257	167	139	110	1
	168,3-108-168,3	257	182	139	111	1
	168,3-114,3-168,3	257	184	139	113	1
	168,3-139,7-168,3	257	211	139	113	1

FIG.15



MAT: AISI 316L

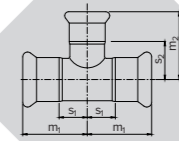
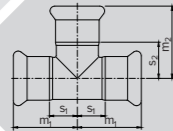

FIG.16



MAT: AISI 316L



TE IGUAL
EQUAL TEE

NSF

Dimensiones Dimensions	m ₁	m ₂	s ₁	s ₂	Nº piezas/Bolsas Nº pieces/Bag
10	29	27	18	16	20
NSF 12	28,3	24,5	12,3	18,5	20
NSF 15	32	39	12	19	20
NSF 18	34	39	14	19	20
NSF 22	35,5	42	16	21	20
◀ FM ▶ NSF 28	41	47	19	25	10
◀ FM ▶ NSF 35	50	53	24	27	10
◀ FM ▶ NSF 42	57	60	27	30	4
◀ FM ▶ NSF 54	68	71	34	37	2
◀ FM ▶ NSF 76,1	113	110	59	55	1
◀ FM ▶ NSF 88,9	128	128	72	69	1
◀ FM ▶ NSF 108	150	154	81	85	1
NSF 114,3	155	157	83	85	1
NSF 139,7	197	197	99	99	1
NSF 168,3	257	235	139	118	1

ENTRONQUE MACHO
MALE ADAPTOR

FIG.18



MAT: AISI 316L

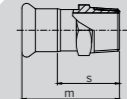

Dimensiones Dimensions	m	s	Nº piezas/Bolsas Nº pieces/Bag
10-R 3/8"	29	18	20
NSF 12-R 1/2"	51	35	20
NSF 15-R 3/8"	48	28	20
NSF 15-R 1/2"	53,5	33,5	20
NSF 15-R 3/4"	57,5	37,5	20
NSF 18-R 1/2"	53,5	33,5	20
NSF 18-R 3/4"	58	38	20
NSF 22-R 1/2"	53	33,5	20
NSF 22-R 3/4"	57	37,5	20
NSF 22-R 1"	60,5	41	20
◀ FM ▶ NSF 28-R 3/4"	60	38	20
◀ FM ▶ NSF 28-R 1"	63	41	20
◀ FM ▶ NSF 28-R 1 1/4"	67	45	20
◀ FM ▶ NSF 35-R 1"	67	41	10
◀ FM ▶ NSF 35-R 1 1/4"	71	45	10
◀ FM ▶ NSF 35-R 1 1/2"	74	48	10
◀ FM ▶ NSF 42-R 1 1/4"	75	45	4
◀ FM ▶ NSF 42-R 1 1/2"	78	48	4
◀ FM ▶ NSF 54-R 1 1/2"	82	48	4
◀ FM ▶ NSF 54-R 2"	84	50	4
◀ FM ▶ NSF 76,1-R 2 1/2"	127,5	74	1
◀ FM ▶ NSF 88,9-R 3"	142	86	1
◀ FM ▶ NSF 108-R 4"	155	73	1

FIG.17



MAT: AISI 316L

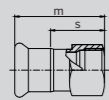

ENTRONQUE HEMBRA
FEMALE ADAPTOR

NSF

Dimensiones Dimensions	m	s	Nº piezas/Bolsas Nº pieces/Bag
10-Rp 3/8"	27	7	20
NSF 12-Rp 1/2"	51,5	22	20
NSF 15-Rp 3/8"	54	34	20
NSF 15-Rp 1/2"	54	34	20
NSF 15-Rp 3/4"	58	38	20
NSF 18-Rp 1/2"	54	34	20
NSF 18-Rp 3/4"	58	38	20
NSF 22-Rp 1/2"	52	32,5	20
NSF 22-Rp 3/4"	58	38	20
NSF 22-Rp 1"	59	39,5	20
◀ FM ▶ NSF 28-Rp 3/4"	60	38	20
◀ FM ▶ NSF 28-Rp 1"	60,5	38,5	20
◀ FM ▶ NSF 28-Rp 1 1/4"	65	43	20
◀ FM ▶ NSF 35-Rp 1"	64	38	10
◀ FM ▶ NSF 35-Rp 1 1/4"	69	43	10
◀ FM ▶ NSF 35-Rp 1 1/2"	73	47	10
◀ FM ▶ NSF 42-Rp 1 1/4"	72	42	4
◀ FM ▶ NSF 42-Rp 1 1/2"	77	47	4
◀ FM ▶ NSF 54-Rp 1 1/2"	81	47	4
◀ FM ▶ NSF 54-Rp 2"	90	56	4
◀ FM ▶ NSF 76,1-Rp 2 1/2"	129	75,5	1
◀ FM ▶ NSF 88,9-Rp 3"	118	60,5	1

BRIDA ADAPTADOR
FLANGES ADAPTOR

NSF

Dimensiones Dimensions	D	k	b	d ₂	h	n*	z	Nº piezas/Bolsas Nº pieces/Bag
15-DN 15	95	65	14	14	61	4	41	1
18-DN 15	95	65	14	14	46	4	26	1
22-DN 20	105	75	16	14	44	4	24	1
◀ FM ▶ 28-DN 25	115	85	16	14	52	4	30	1
◀ FM ▶ 35-DN 32	140	100	16	18	65	4	39	1
◀ FM ▶ 42-DN 40	150	110	16	18	77	4	47	1
◀ FM ▶ 54-DN 50	165	125	18	18	68	4	34	1
◀ FM ▶ 76,1-DN 65	185	145	18	18	114	4	60	1
◀ FM ▶ 88,9-DN 80	200	160	20	18	128	8	70	1
◀ FM ▶ 108-DN 100	220	180	20	18	151	8	82	1

n* = Número de tal. de Ø d₂

FIG.19



MAT: AISI 316L

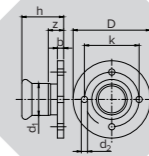
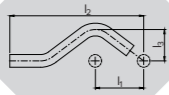

FIG.20



MAT: AISI 316L



CURVA DESVÍO
PRE-FORMED PIPE BRIDGE

NSF

NSF

Dimensiones Dimensions	l ₁	l ₂	l ₃	Nº piezas/Bolsas Nº pieces/Bag
12	57	158	37	20
15	57	158	37	20
18	60	165	40	20
22	65	178	44	20
◀ FM ▶ 28	74	210	50	10

CURVA DESVÍO DOBLE
PIPE BRIDGE

◀ FM ▶

Dimensiones Dimensions	Nº piezas/Bolsas Nº pieces/Bag
12	20
15	20
18	20
22	20
◀ FM ▶ 28	10

FIG.23

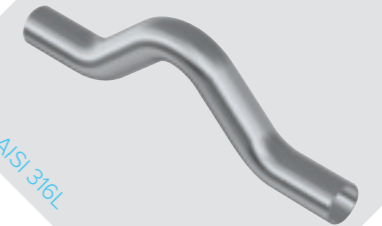

MAT: AISI 316L

FIG.21



MAT: AISI 316L

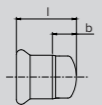

TAPÓN
PLUG

NSF

NSF

Dimensiones Dimensions	l	b	Nº piezas/Bolsas Nº pieces/Bag
15	36	16	20
18	36	16	10
22	40	20,5	10
◀ FM ▶ 28	42	20	10
◀ FM ▶ 35	51	25	10
◀ FM ▶ 42	54	24	4
◀ FM ▶ 54	59	25	4
◀ FM ▶ 76,1	90	36	1
◀ FM ▶ 88,9	102	45	1
◀ FM ▶ 108	125	56	1

UNIÓN 3 PZS
3 PCS ADAPTOR

Dimensiones Dimensions	Nº piezas/Bolsas Nº pieces/Bag
15	20
18	10
22	10
28	10
35	10
42	4
54	4

FIG.24



MAT: AISI 316L

FIG.22



MAT: AISI 316L

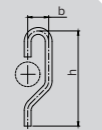

BAJANTE DESVÍO DOBLE
AIR TUBE PIPE BRIDGE

NSF

NSF

Dimensiones Dimensions	b	h	Nº piezas/Bolsas Nº pieces/Bag
15	46	208	10
18	54	218	10
22	68	246	10
28	86	283	10

◀ FM ▶

CURVA DESVÍO DOBLE 1/2 MANGUITO
FF PIPE BRIDGE

Dimensiones Dimensions	Nº piezas/Bolsas Nº pieces/Bag
12	20
15	20
18	20
22	20
◀ FM ▶ 28	10

FIG.25

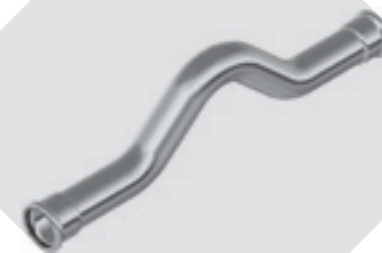

MAT: AISI 316L

FIG.26



MAT: AISI 316L

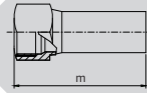

CONECTOR HEMBRA
FEMALE CONNECTOR

NSF

Dimensiones Dimensions	m	Nº piezas/Bolsas Nº pieces/Bag
15-1/2"	58	20
18-1/2"	58	20
18-3/4"	62	20
22-1/2"	58	20
22-3/4"	62	20
◀ FM ▶ 28-3/4"	67	20
◀ FM ▶ 28-1"	69	20
◀ FM ▶ 35-1 1/4"	76	10
◀ FM ▶ 42-1 1/2"	83	4
◀ FM ▶ 54-2"	98,5	4

FIG.29



TUBERÍA METÁLICA FLEXIBLE
FLEXIBLE TUBES

Dimensiones disponibles desde 15 a 108 mm.
Según especificaciones del cliente.

- Longitud mínima 400 mm
- Longitud máxima 1.500 mm

Available dimensions from 15 to 108 mm
according to customers' requirements.

- Minimum length 400 mm
- Maximum length 1500 mm

FIG.27



MAT: AISI 316L

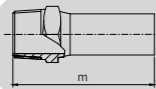

CONECTOR MACHO
MALE CONNECTOR

NSF

Dimensiones Dimensions	m	Nº piezas/Bolsas Nº pieces/Bag
15-1/2"	60	20
18-1/2"	60	20
18-3/4"	64	20
22-1/2"	60	20
22-3/4"	64	20
◀ FM ▶ 28-3/4"	69	20
◀ FM ▶ 28-1"	71	20
◀ FM ▶ 35-1 1/4"	81	10
◀ FM ▶ 42-1 1/2"	88	4
◀ FM ▶ 54-2"	93	4

FIG.30



NSF CRUZ IGUAL O REDUCIDA
EQUAL OR REDUCED CROSS

Dimensiones disponibles desde 15 a 108 mm.
Según especificaciones del cliente.

Available dimensions from 15 to 108 mm
according to customers' requirements.

FIG.28

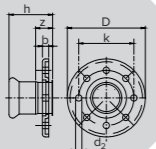

BRIDA LOCA ADAPTADOR
PRESS FLANGED ADAPTOR

NSF

Dimensiones Dimensions	D	k	b	d ₂	h	n*	z	Nº piezas/Bolsas Nº pieces/Bag
◀ FM ▶ 54-DN 50	165	125	19	17,5	78	4	44	1
◀ FM ▶ 76,1-DN 65	185	145	20	17,5	112	4	70	1
◀ FM ▶ 88,9-DN 80	200	160	20	17,5	128	8	70	1
◀ FM ▶ 108-DN 100	220	180	20	17,5	161	8	86	1
114,3-DN 100	220	180	20	18	109	8	36	1
139,7-DN 125	250	210	22	18	138	8	41	1
168,3-DN 150	285	240	24	22	171	8	54	1

VÁLVULA DE BOLA 3 PZS
3 PCS SS BALL VALVE PRESS X PRESS

Dimensiones Dimensions	s	l	w	h	m	Nº piezas/Bolsas Nº pieces/Bag
15	20	111	110	63	71	1
18	20	111	110	63	71	1
22	19,5	130	135	68	91	1
28	22	141	135	70	97	1
35	26	159	160	85	107	1
42	30	180	200	90	120	1
54	34	203	210	100	135	1
76,1	54	289	320	145	181	1
88,9	58	340	320	155	224	1
108	69	424	320	170	286	1

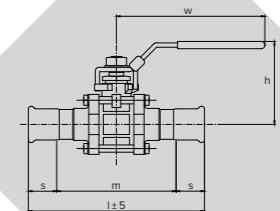
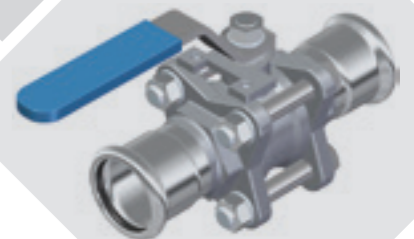

FIG.31



MAT: AISI 316L

FIG.32



MAT: AISI 316L

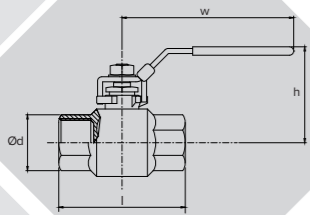

VÁLVULA DE BOLA 2 PZS
2 PCS SS BALL VALVE FULL PORT

DN	NPS	d	l	h	w
8	1/4"	10	50	50	104
10	3/8"	12	50	50	104
15	1/2"	15	55	51,5	104
20	3/4"	20	70	62	122
25	1"	25	83	65	122
32	1-1/4"	32	91	82	180
40	1-1/2"	38	103	88	205
50	2"	50	120	106	219

NSF

CODO 90° H TUERCA LOCA
90° F ANGLE ADAPTOR WITH SWIVEL NUT

Dimensiones Dimensions	m ₁	s ₁	m ₂	s ₂	Nº piezas/Bolsas Nº pieces/Bag
15-Rp 1/2"	48	28	48	39	20
18-Rp 1/2"	52	32	62	53	20
18-Rp 3/4"	52	32	60	51	20
22-Rp 3/4"	61	40	70	61	20
◀ FM ▶ 28-Rp 1"	71,5	49	83	73	10
◀ FM ▶ 35-Rp 1 1/4"	86	60	101	89	10
◀ FM ▶ 42-Rp 1 1/2"	112	82	126,5	115	4
◀ FM ▶ 54-Rp 2"	105	71,5	119	106,5	4

FIG.35



MAT: AISI 316L

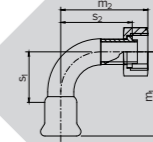
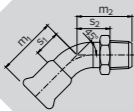

FIG.33



MAT: AISI 316L



CODO 45° ROSCA MACHO
45° MALE ANGLE ADAPTOR

Dimensiones Dimensions	m ₁	s ₁	m ₂	s ₂	Nº piezas/Bolsas Nº pieces/Bag
15-R 1/2"	34,5	14	40	25	20
18-R 1/2"	36	16	41,5	26,5	20
18-R 3/4"	36	16	45,5	28,5	20
22-R 3/4"	41	20	48,5	31,5	20
◀ FM ▶ 28-R 1"	46	24	56	36	10

NSF

NSF

TE SALIDA CENTRAL ROSCA MACHO
MALE TEE THREADED ADAPTOR

Dimensiones Dimensions	m ₁	m ₂	s ₁	s ₂	Nº piezas/Bolsas Nº pieces/Bag
15-R 3/8"	32	34,5	12	21,5	20
15-R 1/2"	32	36	12	21	20
18-R 1/2"	34	36,5	14	21,5	20
18-R 3/4"	34	40,5	14	23,5	20
22-R 3/4"	35,5	43,5	16	26,5	20
◀ FM ▶ 28-R 1"	41	49,5	19	29,5	10
◀ FM ▶ 35-R 1 1/4"	50	56,5	24	34,5	10

FIG.36



MAT: AISI 316L

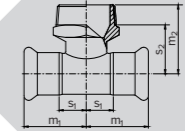
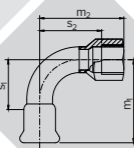

FIG.34



MAT: AISI 316L



CODO 90° ROSCA HEMBRA
90° FEMALE ANGLE ADAPTOR

Dimensiones Dimensions	m ₁	s ₁	m ₂	s ₂	Nº piezas/Bolsas Nº pieces/Bag
15-Rp 3/8"	48	28	52	39	20
15-Rp 1/2"	48	28	52	39	20
18-Rp 1/2"	52	32	58	45	20
18-Rp 3/4"	52	32	62	47	20
22-Rp 3/4"	61	40	67	52	20
◀ FM ▶ 28-Rp 1"	71,5	49	78	61	10
◀ FM ▶ 35-Rp 1 1/4"	86	60	94	75	10

NSF

NSF

CRUZ ROSCADA MACHO
MALE THREADED CROSS

Dimensiones disponibles desde 15 a 108 mm.
Según especificaciones del cliente.

Available dimensions from 15 to 108 mm
according to customers' requirements.

FIG.37



FIG.38



MAT: AISI 316L

CRUZ ROSCADA HEMBRA
FEMALE THREADED CROSS

NSF

Dimensiones disponibles desde 15 a 108 mm.
Según especificaciones del cliente.

Available dimensions from 15 to 108 mm
according to customers' requirements.

FIG.39

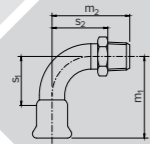

CODO 90° H ROSCA MACHO
90° MALE ANGLE ADAPTOR

NSF

Dimensiones Dimensions	m ₁	s ₁	m ₂	s ₂	Nº piezas/Bolsas Nº pieces/Bag
15-R 3/8"	48	28	49	36	20
15-R 1/2"	48	28	53	38	20
18-R 1/2"	52	32	57	42	20
18-R 3/4"	52	32	61	44	20
22-R 3/4"	61	40	68	51	20
◀ FM ▶ 28-R 1"	71,5	49	81	61	10
◀ FM ▶ 35-R 1 1/4"	86	60	96	74	10
◀ FM ▶ 42-R 1 1/2"	112	82	121	96	4
◀ FM ▶ 54-R 2"	105,2	71,5	112	85	2

FIG.41

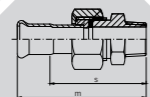

TUERCA MACHO 3 PZS
MALE UNION CONNECTOR GAS

NSF

Dimensiones Dimensions	m	s	Nº piezas/Bolsas Nº pieces/Bag
12-3/8"	72	52	20
15-1/2"	72	52	20
15-3/4"	74,5	54,5	20
18-1/2"	74	54	20
18-3/4"	76,5	56,5	20
22-1"	83,5	64	20
22-3/4"	79	58	20
◀ FM ▶ 28-1"	90,5	68,5	20
◀ FM ▶ 28-1 1/4"	94	72	20
◀ FM ▶ 35-1 1/4"	104,5	78,5	10
◀ FM ▶ 42-1 1/2"	113	83	4
◀ FM ▶ 54-2"	134	100	2

TUERCA HEMBRA 3 PZS
FEMALE UNION CONNECTOR GAS

NSF

Dimensiones Dimensions	m	s	Nº piezas/Bolsas Nº pieces/Bag
12-3/8"	67	47	20
15-1/2"	67	47	20
15-3/4"	69	49	20
18-1/2"	69	47	20
18-3/4"	71	51	20
22-1"	77	57,5	20
22-3/4"	73,5	54	20
◀ FM ▶ 28-1"	84,5	62,5	20
◀ FM ▶ 28-1 1/4"	84,5	62,5	20
◀ FM ▶ 35-1 1/4"	96	70	10
◀ FM ▶ 42-1 1/2"	104,5	74,5	4
◀ FM ▶ 54-2"	126,5	92,5	2

FIG.42



MAT: AISI 316L

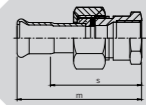

TUERCA HEMBRA 2 PZS
UNION GAS FEMALE THREADED

NSF

Dimensiones Dimensions	m	s	Nº piezas/Bolsas Nº pieces/Bag
15-1/2"	63,5	34,5	20
15-3/4"	46	19,5	20
18-1/2"	65,5	34,5	20
18-3/4"	48	21,5	20
22-3/4"	65	36,5	20
22-1"	50,5	23,5	20
28-1"	73	39,5	20
◀ FM ▶ 28-1 1/4"	58	27,5	20
◀ FM ▶ 35-1 1/4"	76	38	10
◀ FM ▶ 35-1 1/2"	66,5	32	10
◀ FM ▶ 42-1 1/2"	82,5	41	4
◀ FM ▶ 42-2"	75	35,5	4
◀ FM ▶ 54-2"	91	47	2

FIG.45



MAT: AISI 316L

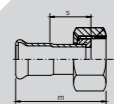

RACORD 3 PZS EUROPEO
STRAIGHT UNION WITH
PRESSFITTING ON BOTH ENDS

NSF

Dimensiones Dimensions	m	s	Nº piezas/Bolsas Nº pieces/Bag
12	95	20	20
15	95	20	20
18	99	20	20
22	104	19,4	20
◀ FM ▶ 28	117	22,2	20
◀ FM ▶ 35	135,5	26	10
◀ FM ▶ 42	152	30	4
◀ FM ▶ 54	157	35	2

FIG.46



MAT: AISI 316L

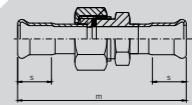
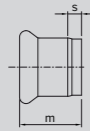

FIG.47



MAT: AISI 316L



MEDIO MANGUITO
HALF COUPLING

Dimensiones Dimensions	m	s	Nº piezas/Bolsas Nº piezas/Bag
15	28	8	20
18	28	8	20
22	27,5	8	20
28	30,5	8	20
35	34	8	10
42	38	8	4
54	42	8	4
76,1	69,5	16	1
88,9	79,5	21,5	1
108	96,5	27,5	1

CODO 15° HEMBRA-HEMBRA
15° FEMALE-FEMALE ELBOW

Dimensiones Dimensions	m	s	Nº piezas/Bolsas Nº piezas/Bag
15	28,5	9	20
18	28,5	9,5	20
22	30,7	10,5	20
28	34	12	10
35	39	13	10
42	46	16	4
54	53	19	2
76,1	78	24,5	1
88,9	81,5	24	1
108	93,5	24	1

FIG.50



MAT: AISI 316L

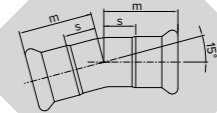

CODO 30° HEMBRA-HEMBRA
30° FEMALE-FEMALE ELBOW

Dimensiones Dimensions	m	s	Nº piezas/Bolsas Nº piezas/Bag
15	31	11	20
18	32	12	20
22	34,5	15	20
28	40	17,5	10
35	46,5	20,5	10
42	56,5	26,5	4
54	58	24	2
76,1	93,5	40,5	1
88,9	97	39,5	1
108	108	39	1

CODO 60° HEMBRA-HEMBRA
60° FEMALE-FEMALE ELBOW

Dimensiones Dimensions	m	s	Nº piezas/Bolsas Nº piezas/Bag
15	38	18	20
18	40,5	20,5	20
22	46,5	25,5	20
28	53	31	10
35	63	37	10
42	80	50	4
54	78	44	2
76,1	129	75	1
88,9	132,5	76	1
108	141,5	72,5	1

FIG.51



MAT: AISI 316L

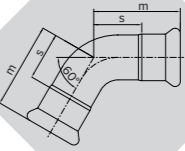

FIG.48



MAT: AISI 316L

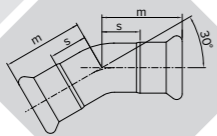
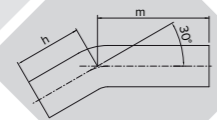

FIG.49



MAT: AISI 316L



CODO DE AJUSTE 30°
30° ELBOW WITH PLAIN ENDS

Dimensiones Dimensions	m	h	Nº piezas/Bolsas Nº piezas/Bag
15	103	53	20
18	100	50	20
22	95	45	20
28	88,5	48,5	10
35	160,5	80,5	10
42	194,5	94,5	4
54	229	129	2
76,1	111,5	111,5	1
88,9	118,5	118,5	1
108	145	145	1

BRIDA ADAPTADOR PN6
FLANGES ADAPTOR PN6

Dimensiones Dimensions	D	k	b	d ₂	h	n*	z	Nº piezas/Bolsas Nº piezas/Bag
15-DN 15	80	55	12	11	61	4	41	1
18-DN 15	80	55	12	11	46	4	26	1
22-DN 20	90	65	14	11	52,5	4	33	1
28-DN 25	100	75	14	11	52	4	30	1
35-DN 32	120	90	16	14	65	4	39	1
42-DN 40	130	100	16	14	77	4	47	1
54-DN 50	140	110	16	14	68	4	34	1
76,1-DN 65	160	130	16	14	114	4	60	1
88,9-DN 80	190	150	18	18	128	4	70	1
108-DN 100	210	170	18	18	158	4	89	1

n* = Número de tal. de Ø d₂

FIG.52



MAT: AISI 316L

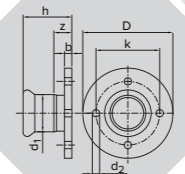
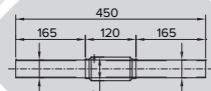

FIG.53



MAT: AISI 316L



PASA CUBIERTA CON CAMISA DE Fe
PIPE PENETRATION

Dimensiones Dimensions	d	D	Nº piezas/Bolsas Nº pieces/Bag
15	15	25	1
18	18	30	1
22	22	33	1
28	28	37	1
35	35	43,5	1
42	42	53	1
54	54	69	1
76,1	76,1	88,5	1
88,9	88,9	107	1
108	108	131,5	1

CODO 75° HEMBRA-HEMBRA
75° FEMALE-FEMALE ELBOW

Dimensiones Dimensions	m	s	Nº piezas/Bolsas Nº pieces/Bag
42	94,5	64,5	4
54	90	56,5	2
76,1	150,5	96,5	1
88,9	154	97,5	1
108	162	93,5	1

FIG.56



MAT: AISI 316L

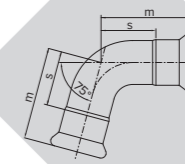
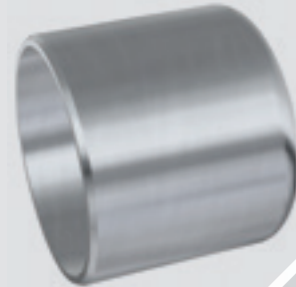
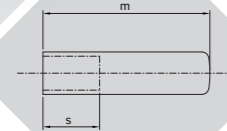

FIG.54



MAT: AISI 316L



TAPÓN MACHO
MALE PLUG

Dimensiones Dimensions	s	m	Nº piezas/Bolsas Nº pieces/Bag
15	20	59	20
18	21	63	20
22	21	66	20
28	24	75	10
35	27	83	10
42	32	104	4
54	39	118	4
76,1	55	172	1
88,9	64	192	1
108	78	226	1

CODO 10° HEMBRA-HEMBRA
10° FEMALE-FEMALE ELBOW

Dimensiones Dimensions	m	s	Nº piezas/Bolsas Nº pieces/Bag
42	43	13	4
54	46	12	2
76,1	73	19	1
88,9	76,5	20	1
108	89	20	1

FIG.57



MAT: AISI 316L

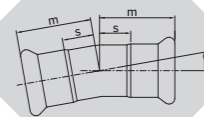
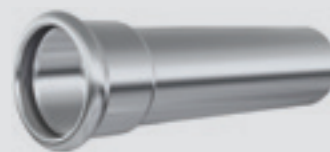
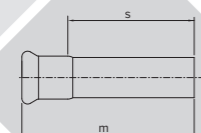

FIG.55



MAT: AISI 316L



ADAPTADOR PARA SOLDAR
WELD ADAPTOR

Dimensiones Dimensions	m	s	Nº piezas/Bolsas Nº pieces/Bag
DN 15	130	110	20
DN 18	130	110	20
DN 22	129,5	110	20
DN 28	132,5	110	20
DN 35	136	110	10
DN 42	140	110	4
DN 54	144	110	2

CODO DE AJUSTE 60°
60° ELBOW WITH PLAIN ENDS

Dimensiones Dimensions	m	h	Nº piezas/Bolsas Nº pieces/Bag
15	110	60	20
18	108	58	20
22	106	56	20
28	102	62	10
35	177	97	10
42	218	118	4
54	259	159	2
76,1	147	147	1
88,9	154	154	1
108	185	185	1

FIG.58



MAT: AISI 316L

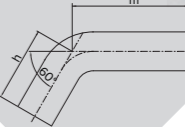

FIG.59

CODO DE AJUSTE 15°
15° ELBOW WITH PLAIN ENDS

Dimensiones Dimensions	m	h	Nº piezas/Bolsas Nº pieces/Bag
15	97	47	20
18	96,5	46,5	20
22	90,5	40,5	20
28	83	43	10
35	153	73	10
42	184	84	4
54	216	116	2
76,1	96	96	1
88,9	103	103	1
108	127	127	1

CODO 15° MACHO-HEMBRA
15° MALE-FEMALE ELBOW

Dimensiones Dimensions	m	h	s	Nº piezas/Bolsas Nº pieces/Bag
15	28	41	8	20
18	28,5	43,5	8,5	20
22	30	44,5	10,5	20
28	34	48	11,5	10
35	39	50	13	10
42	46	56,5	16	4
54	53	65	19,5	2
76,1	78	96	24,5	1
88,9	81,5	103	24	1
108	96	127	27,5	1

FIG.64



MAT: AISI 316L

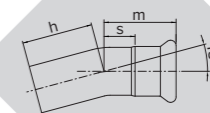

FIG.65



MAT: AISI 316L

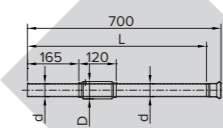

FIG.66



MAT: AISI 316L

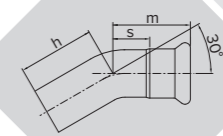

FIG.61

MANGUITO CON TUBO RANURADO
TRANSITION FOR GROOVED COUPLING

Dimensiones Dimensions	D	L	Z	Nº piezas/Bolsas Nº pieces/Bag
DN 28 x 33,7	33,7	80	40	20
DN 35 x 42,4	42,4	88,5	40	10
DN 42 x 48,3	48,3	96	40	4
DN 54 x 60,3	60,3	107	40	4
DN 76,1 x 73	73	152	40	1
DN 76,1 x 76,1	76,1	152	40	1
DN 88,9 x 88,9	88,9	166	40	1
DN 108 x 114,3	114,3	188,5	40	1

PASA CUBIERTA M-H
M-F PIPE PENETRATION

Dimensiones Dimensions	d	D	L	Diámetro x Esp. O.D. x wall thickness
15	15	25	672	1
18	18	30	672	1
22	22	33	672	1
28	28	37	670	1
35	35	43,5	666	1
42	42	53	662	1
54	54	69	658	1
76,1	76,1	88,5	630	1
88,9	88,9	107	620	1
108	108	131,5	603	1

FIG.63

CODO DE AJUSTE 75°
75° ELBOW WITH PLAIN ENDS

Dimensiones Dimensions	m	h	Nº piezas/Bolsas Nº pieces/Bag
15	115	65	20
18	114	64	20
22	112	62	20
28	110	70	10
35	187	107	10
42	233	133	4
54	278	178	2
76,1	168,5	168,5	1
88,9	175,5	175,5	1
108	209,5	209,5	1

CODO 30° MACHO-HEMBRA
30° MALE-FEMALE ELBOW

Dimensiones Dimensions	m	h	s	Nº piezas/Bolsas Nº pieces/Bag
15	31	44	11	20
18	32	47	12	20
22	34,5	49	15	20
28	40	53,5	17,5	10
35	46,5	57,5	20,5	10
42	56,5	67	26,5	4
54	66,2	78	32,5	2
76,1	93,5	111,5	40	1
88,9	97	118,5	39,5	1
108	114	145	45	1

MAT: AISI 316L

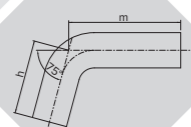
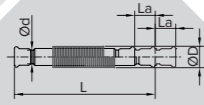

FIG.71



MAT: AISI 316L



COMPENSADOR DILATACIÓN
ELONGATION COMPENSATOR

Dimensiones Dimensions	øD	La	L	Nº piezas/Bolsas Nº pieces/Bag
15	26	15	235	1
18	26	15	235	1
22	31	15	241	1
28	40	15	241	1
35	40	15	251	1
42	48	15	261	1
54	71	15	269	1
76,1	88	20	353	1
88,9	105	25	494	1
108	128	25	434	1

CODO PLACA DOBLE
F DOUBLE ELBOW WITH WALLNUT

Dimensiones Dimensions	h	m	l	l ₁	ød	e.c.	s	s ₁
NW-15-Rp 1/2"	44	14	50	30	5	39	28	17

FIG.76



MAT: AISI 316L

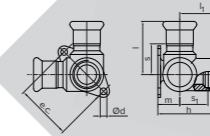

JUNTAS EPDM
EPDM O-RING

Dimensiones
Dimensions

Nº piezas/Bolsas
Nº pieces/Bag

10	10
12	10
15	10
18	10
22	10
28	10
35	10
42	10
54	10
76,1	4
88,9	4
108	4
114,3	1
139,7	1
168,3	1

EPDM



NEW

JUNTAS FKM
FKM O-RING

Dimensiones
Dimensions

Nº piezas/Bolsas
Nº pieces/Bag

10	10
12	10
15	10
18	10
22	10
28	10
35	10
42	10
54	10
76,1	4
88,9	4
108	4
114,3	1
139,7	1
168,3	1

FKM

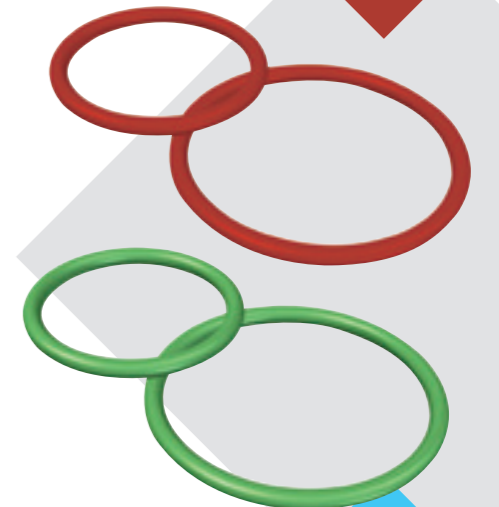
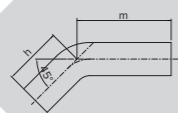

FIG.72



MAT: AISI 316L



CODO DE AJUSTE 45°
45° ELBOW WITH PLAIN ENDS

Dimensiones Dimensions	m	h	Nº piezas/Bolsas Nº pieces/Bag
15	106,5	56,5	20
18	104	54	20
22	100	50	20
28	95	55	10
35	168,5	88,5	10
42	205,5	105,5	4
54	243	143	2
76,1	128	128	1
88,9	135	135	1
108	164	164	1

FIG.73



MAT: AISI 316L

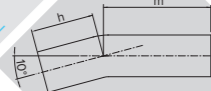

CODO DE AJUSTE 10°
10° ELBOW WITH PLAIN ENDS

Dimensiones Dimensions	m	h	Nº piezas/Bolsas Nº pieces/Bag
15	99	49	20
18	96	46	20
22	89	39	20
28	80,7	40,7	10
35	150,7	70,7	10
42	180,7	80,7	4
54	211,5	111,5	2
76,1	91	91	1
88,9	98	98	1
108	121,5	121,5	1

NOTA: Nuestros accesorios de 15 a 54mm vienen equipados con junta EPDM con función LBP.
NOTE: Our fittings from 15 to 54mm are fitted with an EPDM LBP-function o-ring.

TUBO SOLDADO
WELDED TUBES

Dimensiones <i>Dimensions</i>	Diámetro x Esp. <i>O.D. x wall thickness</i>	Diámetro x Esp. <i>O.D. x wall thickness</i>
DN 8	10 x 1	10 x 1
DN 10	12 x 1	12 x 1
DN 12	15 x 1	15 x 0,6
DN 15	18 x 1	18 x 0,7
DN 20	22 x 1,2	22 x 0,7
DN 25	28 x 1,2	28 x 0,8
DN 32	35 x 1,5	35 x 1
DN 40	42 x 1,5	42 x 1,2
DN 50	54 x 1,5	54 x 1,2
DN 65	76,1 x 2	76,1 x 2
DN 80	88,9 x 2	88,9 x 2
DN 100	108 x 2	108 x 2
DN 100	114,3 x 2	114,3 x 2
DN 125	139,7 x 2,6	139,7 x 2
DN 150	168,3 x 2,6	168,3 x 2



MAT: AISI 316L - AISI 304

Longitud
barras
5 y 6 m
según normativa.
*Length 5/6 mts
according
to norms.*

La herramienta de prensar puede ser manual, con batería o eléctrica. Para cada diámetro existe la correspondiente mordaza fácilmente intercambiable que debe ser introducida en el cilindro de la herramienta.

La mayoría de las máquinas existentes en el mercado pueden prensar accesorios NUMEPRESS desde el diámetro 15 mm hasta 54 mm, pero deberemos asegurarnos que la fuerza de prensado es al menos 32 kN y la mordaza de perfil M.

Para las dimensiones de 76,1 a 168,3 existen otras máquinas con mayor fuerza de prensado.

The pressfitting tool can be manual, battery or electrically-powered. There is a corresponding easily exchangeable jaw for each diameter which is placed in the tool cylinder.

Most of the machines that exist in the market allow pressing NUMEPRESS fittings properly from diameter 15 mm to diameter 54 mm. Each diameter needs its own jaw or collar. There is one machine that presses from 15 mm to 54 mm and another one that presses from 76,1 mm to 168,3 mm (ask for bigger dimensions).

M profile jaws or collars should always be used. In case of doubt, please ask our technical department.



15'
CARGA
CHARGING

Datos técnicos Technical data	UAP4L	MAP2L19	UAP100L	ECO 301	ACO 401
Fuente de alimentación Power supply	18 V / 3 Ah	1.5 Ah / 3 Ah	18 V / 3 Ah	220–240 V / 50 Hz	18 V / 3 Ah
Potencia Power	-	-	-	560 W	400 W
Dimensiones (L x W x H) Dimensions (L x W x H)	512 x 81 x 317 mm	370 x 75 x 116 mm	567 x 81 x 359 mm	420 x 85 x 110 mm	660 x 100 x 250 mm
Peso Weight	4,3 Kg	3,1 Kg	12,7 Kg	5 Kg	13 Kg
Fuerza del pistón Piston force	32 kN	19 kN	120 kN	45 kN	100 kN

CONDICIONES GENERALES DE VENTA

Las ventas efectuadas por ISOTUBI, S.L., quedan sujetas a las condiciones de venta especificadas a continuación, de no mediar renuncia expresa por parte de ISOTUBI, S.L. para alguna de las cláusulas en caso de pedidos especiales.

1. Los precios deben consultarse con nuestro manual de tarifas vigente en el momento de efectuar el pedido.
2. ISOTUBI, S.L. no se responsabiliza en ningún caso del transporte. Las mercancías viajan siempre por cuenta y riesgo del comprador, incluso si son enviadas "franco destino".
3. ISOTUBI, S.L. establecerá anualmente el importe mínimo del pedido a partir del cual, los portes serán a cargo del vendedor.
4. El plazo de entrega indicado en las confirmaciones de pedido únicamente tiene carácter indicativo.
5. El vendedor se reserva el derecho de enviar una cantidad no inferior ni superior en un 10% a la inicialmente pedida por el cliente, salvo en los casos en que quede especificado por escrito.
6. La falta de pago de una factura a su vencimiento dará derecho a ISOTUBI, S.L. a la paralización en la entrega de cualquier pedido posterior que pudiera estar pendiente de servir, hasta que la situación quede regularizada.
7. En caso de persistencia, el vendedor se reserva el derecho a emprender las acciones legales que pudieran corresponder.
8. ISOTUBI, S.L. no aceptará devoluciones de material una vez transcurridos 15 días desde la fecha de entrega. En toda devolución será obligatorio adjuntar al material devuelto, la documentación de entrega y un informe de los defectos observados en el material. En el caso de reconocer como defectuoso el material devuelto, ISOTUBI, S.L. procederá a su sustitución quedando exentos de otro daño o perjuicio. No se aceptará devolución o reclamación alguna cuando el material haya sido objeto de manipulación por parte del comprador. ISOTUBI, S.L. garantiza el sistema NUMEPRESS salvo en los casos en los que el material utilizado en las instalaciones no sea en su totalidad fabricado por ISOTUBI, S.L.
9. ISOTUBI, S.L. no aceptará reclamaciones debidas a una mala utilización de las máquinas de prensar.
10. Para cualquier otro caso no recogido en las presentes condiciones, ISOTUBI, S.L. se acoge a la normativa legal vigente en materia de relaciones comerciales.

GENERAL SALES TERMS

All sales made by ISOTUBI, S.L. are according to these general sales terms.

1. All pieces need to be inquired before placing the definitive orders.
2. ISOTUBI, S.L. declines all responsibility for potential damages occurred during transportation.
3. ISOTUBI, S.L. will communicate the minimum amount needed in each order to include transportation cost in the price.
4. The delivery term showed in our order confirmation has only an indicative character.
5. The seller has the right to send a +/- 10% of the quantity ordered by the customer.
6. In case of a non-payment of an invoice at its due-date, ISOTUBI, S.L. will stop all further deliveries.
7. In case of a definitive unpayment ISOTUBI, S.L. will initiate legal actions.
8. ISOTUBI, S.L. won't accept returns of material after 15 days from delivery. In case of a return, it is compulsory to send all documents and information concerning delivery and a report of the defects. ISOTUBI, S.L. won't accept any return of material in case of a bad use of the product by the customer. We warranty our system exclusively when both tubes and fittings have been delivered by ISOTUBI, S.L.
9. ISOTUBI, S.L. won't accept any complaint caused by a negligence in the use of the pressing machines.

STAINLESS STEEL
PRESSFITTINGS & TUBES

EXPORT
WORLDWIDE PRESENCE



WWW.ISOTUBI.COM





Oficinas: Pol. Ind. Santa Rita. c/ Mecànica, 6
08755 Castellbisbal (Barcelona). Spain
Almacén 1: Pol. Ind. Agripina. c/ Comunicació, 7
08755 Castellbisbal (Barcelona). Spain
Almacén 2: Pol. Ind. Fuente del Jarro
C/Gibraltar, 12. 46988 Paterna (Valencia). Spain
Tel. + 34 93 771 16 97 • Fax. + 34 93 772 19 43
isotubi@isotubi.com • www.isotubi.com

ISO
TUBI
TUBOS Y ACCESORIOS
DE ACERO INOXIDABLE