

**PVC-U
PRESSURE
FITTINGS**

METRIC SERIES

ELBOWS AND BENDS <i>CODOS Y CURVAS</i>	01	PAG. 68
TEES AND CROSSES <i>TÉS Y CRUCES</i>	02	PAG. 72
SOCKETS AND REDUCERS <i>MANGUITOS Y REDUCCIONES</i>	03	PAG. 75
CAPS <i>TAPONES</i>	04	PAG. 78
NIPPLES <i>MACHONES</i>	05	PAG. 79
RUBBER-RING JOINT FITTINGS <i>ACCESORIOS JUNTA ELÁSTICA</i>	06	PAG. 83
VICTAULIC® COUPLING <i>ENLACE VICTAULIC®</i>	07	PAG. 87
FLANGES AND BOLTS <i>BRIDAS Y TORNILLERÍA</i>	08	PAG. 88
UNIONS <i>ENLACES 3 PIEZAS</i>	09	PAG. 94
SPIGOTS <i>ENLACES ESPIGA</i>	10	PAG. 99
MANIFOLDS FOR ELECTRIC VALVES <i>COLECTORES PARA ELECTROVÁLVULAS</i>	11	PAG. 100
SIGHT GLASSES <i>VISORES DE LÍQUIDOS</i>	12	PAG. 103
FLOWMETERS <i>CAUDALÍMETROS</i>	13	PAG. 104
SOLVENT CEMENT / CLEANER <i>ADHESIVOS / DISOLVENTES</i>	14	PAG. 107

FEATURES

- PVC-U fittings for the PVC pipe union.
- Material: PVC-U.
- Injection moulding.
- Density: 1,4 g/cm³.
- Color: grey RAL 7024.
- Dimensions: socket fittings D16 to D400 and threaded fittings from ¼" to 4".
- Dimensions:
 - Socket fittings according to EN 1452-3.
 - Threaded fittings according to ISO 7/1.
- For tubes according to EN 1452-2.
- Socket fittings: we recommend solvent cement THF basis.
- Threaded fittings: in order to guarantee the watertightness, PTFE thread-wrap tape must be used. In PVC-U metal unions, use PVC-U as the male.

CARACTERÍSTICAS

- Accesorios en PVC-U para unión de tuberías de PVC.
- Moldeo por inyección.
- Densidad: 1,4 g/cm³.
- Color: gris RAL 7024.
- Dimensiones: accesorios encolar de D16 hasta D400 y accesorios roscar de ¼" a 4".
- Dimensiones:
 - Accesorios encolar según la norma EN 1452-3.
 - Accesorios roscados según la norma ISO 7/1.
- Para tubos según norma EN 1452-2.
- Accesorios encolar: recomendamos el uso de cola a base de THF.
- Accesorios roscados: para garantizar la estanqueidad sólo es admisible el uso de cinta de PTFE. En uniones PVC-U-metal, el macho debe ser el PVC-U.

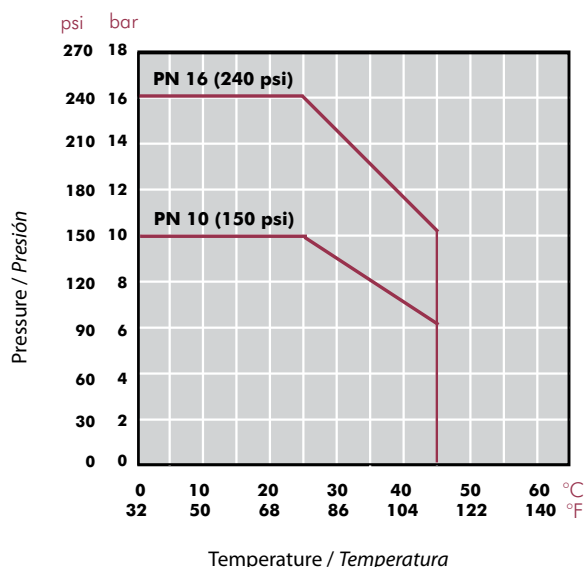

FIG.	Details	Detalles
1	Logo, material, dimensiones, PN	Logo, material, dimensiones, PN
2	European standard, N (Aenor), Kiwa o NF (Afnor)	Norma europea, N (Aenor), Kiwa o NF (Afnor)
3	Marked at 45°	Marcaje a 45°

TECHNICAL CHARACTERISTICS
CARACTERÍSTICAS TÉCNICAS

Unions Uniones	Sizes Medidas	Working pressure at 20°C Presión de servicio a 20°C
Solvent socket / Encolar	D16 - D140	PN 16 (240 psi)
Solvent socket / Encolar	D160 - D315	PN10 (150 psi)
Threaded / Roscar	½" - 4"	PN 10 (150 psi)
Threaded reinforced / Roscar reforzado	½" - 4"	PN 16 (240 psi)

PRESSURE / TEMPERATURE GRAPH
DIAGRAMA PRESIÓN / TEMPERATURA



Life: 50 years
Hydrostatic maximum pressure a component may withstand in continuous service (without overpressure)

Vida útil: 50 años
Presión hidrostática máxima que un componente es capaz de soportar en servicio continuo (sin sobrepresión)

TOLERANCE CHART
TABLA TOLERANCIAS

D	DN	Minimum diameter Diámetro mínimo	Maximum diameter Diámetro máximo
16	10	16.1	16.3
20	15	20.1	20.3
25	20	25.1	25.3
32	25	32.1	32.3
40	32	40.1	40.3
50	40	50.1	50.3
63	50	63.1	63.3
75	65	75.1	75.3
90	80	90.1	90.3
110	100	110.1	110.4
125	110	125.1	125.4
140	125	140.2	140.5
160	150	160.2	160.5
200	175	200.2	200.6
225	200	225.3	225.7
250	225	250.3	250.8
315	300	315.4	316.0

PVC-U ELBOWS CODOS PVC-U

UP. 01. SF - 90° ELBOW

90° elbow

- Female solvent socket
- Metric series

Codo 90°

- Encolar hembra
- Serie métrica

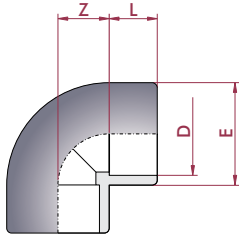

D	DN	PN	REF.	CODE
16	10	16	05 01 016 ³	11655
20	15	16	05 01 020 ¹²³	01712
25	20	16	05 01 025 ¹²³	01713
32	25	16	05 01 032 ²³	01714
40	32	16	05 01 040 ²³	01715
50	40	16	05 01 050 ¹²³	01716
63	50	16	05 01 063 ²³	01717
75	65	16	05 01 075 ²³	01718
90	80	16	05 01 090 ²³	01719
110	100	16	05 01 110 ³	01720
125	110	16	05 01 125 ³	01721
140	125	16	05 01 140 ³	01722
160	150	10	05 01 160 ³	01723
200	175	10	05 01 200 ³	01724
225	200	10	05 01 225 ³	01725
250	225	10	05 01 250	01726
315	300	10	05 01 315	01727
400	353	5	05 01 400 [*]	34807

L	Z	E
14	10	25
16	11	27
19	14	33
22	17	41
26	21	50
31	26	61
38	33	76
44	39	90
51	46	108
61	56	131
69	64	148
76	71	164
86	81	180
106	101	225
119	114	252
131	126	284
164	159	352
206	202	439

UP. 01. SFT - 90° ELBOW

90° adaptor elbow

- Female solvent socket & BSP female thread
- Metric series

Codo 90° mixto

- Encolar hembra y roscar hembra BSP
- Serie métrica

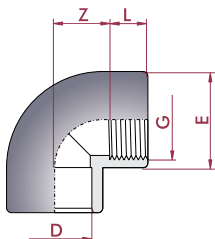

D x G	DN	PN	REF.	CODE
20 x 1/2"	15	10	05 01 420	01728
25 x 3/4"	20	10	05 01 425	01729
32 x 1"	25	10	05 01 432	01730
40 x 1 1/4"	32	10	05 01 440	01731
50 x 1 1/2"	40	10	05 01 450	01732
63 x 2"	50	10	05 01 463	01733
75 x 2 1/2"	65	10	05 01 475 [*]	22596
90 x 3"	80	10	05 01 490 [*]	22597
110 x 4"	100	10	05 01 510 [*]	22598

L	Z	E
14	11	28
16	14	34
19	17	43
20	21	54
20	26	63
24	33	78
44	40	89
51	48	106
61	58	129

UP. 01. SFTR - 90° REINFORCED ELBOW

90° adaptor reinforced elbow

- Female solvent socket & BSP female thread
- Reinforcement in stainless steel
- Metric series

Codo 90° mixto reforzado

- Encolar hembra y roscar hembra BSP
- Refuerzo en acero inoxidable
- Serie métrica

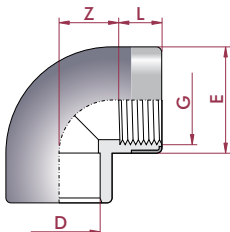

D x G	DN	PN	REF.	CODE
20 x 1/2"	15	16	05 01 820	01740
25 x 3/4"	20	16	05 01 825	01741
32 x 1"	25	16	05 01 832	01742
40 x 1 1/4"	32	16	05 01 840	01743
50 x 1 1/2"	40	16	05 01 850	01744
63 x 2"	50	16	05 01 863	01745

L	Z	E
14	11	28
16	14	34
19	17	43
20	21	54
20	26	63
24	33	78

UP. 01. FT - 90° ELBOW

90° elbow

- BSP female thread

Codo 90°

- Roscar hembra BSP

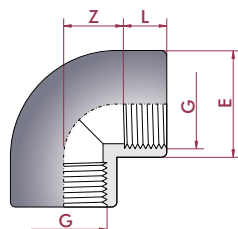

G	DN	PN	REF.	CODE
1/2"	15	10	05 01 620	01734
3/4"	20	10	05 01 625	01735
1"	25	10	05 01 632	01736
1 1/4"	32	10	05 01 640	01737
1 1/2"	40	10	05 01 650	01738
2"	50	10	05 01 663	01739
2 1/2"	65	10	05 01 675 [*]	22587
3"	80	10	05 01 690 [*]	22588
4"	100	10	05 01 710 [*]	22589

L	Z	E
14	11	28
16	14	34
19	17	43
20	21	54
20	26	63
24	33	78
30	54	89
33	66	106
39	80	129

* Distributed product
* Producto comercializado

¹ AFNOR
² KIWA
³ AENOR

UP. 29. SFG - 90° REDUCING ELBOW

90° reducing elbow

- Female solvent socket
- Metric series

Codo 90° reducido

- Encolar hembra
- Serie métrica

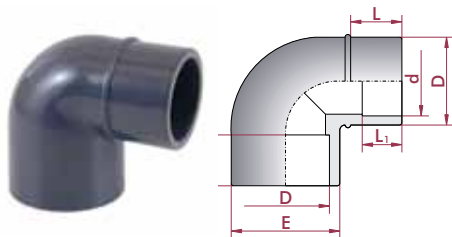

D x D - d	DN	PN	REF.	CODE
50 x 50 - 40	40 x 32	16	05 29 050	02237
63 x 63 - 50	50 x 40	16	05 29 063	02238

L	L ₁	E
31	26	61
38	31	76

UP. 29. SMT - 90° ELBOW

90° elbow

- Female solvent socket & BSP male thread
- Metric series

Codo 90°

- Encolar hembra y roscar macho BSP
- Serie métrica

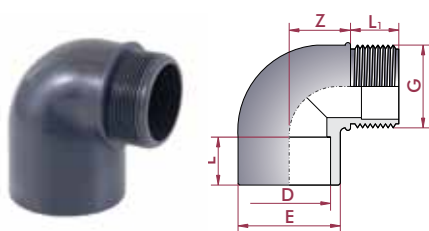

D x G	DN	PN	REF.	CODE
50 x 1 1/2"	40	10	05 02 450	02239
63 x 2"	50	10	05 29 463	02240

L ₁	L	E	Z
21	31	61	38
25	38	76	47

UP. 02. SF - 45° ELBOW

45° elbow

- Female solvent socket
- Metric series

Codo 45°

- Encolar hembra
- Serie métrica

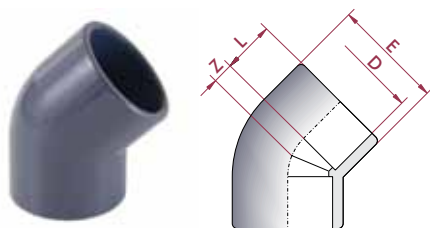

D	DN	PN	REF.	CODE
16	10	16	05 02 016 ³	16307
20	15	16	05 02 020 ¹²³	01746
25	20	16	05 02 025 ¹²³	01747
32	25	16	05 02 032 ¹²³	01748
40	32	16	05 02 040 ¹²³	01749
50	40	16	05 02 050 ²³	01750
63	50	16	05 02 063 ²³	01751
75	65	16	05 02 075 ²³	01752
90	80	16	05 02 090 ²³	01753
110	100	16	05 02 110 ³	01754
125	110	16	05 02 125 ³	01755
140	125	16	05 02 140 ³	01756
160	150	10	05 02 160 ³	01757
200	175	10	05 02 200 ³	01758
225	200	10	05 02 225 ³	01759
250	225	10	05 02 250 ³	01760
315	300	10	05 02 315 ³	01761
400	353	5	05 02 400 [*]	34808

L	Z	E
14	5	22
16	5	28
19	6	35
22	8	43
26	10	52
31	12	58
38	14	76
44	17	93
51	20	109
61	24	133
69	27	148
76	30	164
86	34	180
106	43	225
119	48	252
131	53	284
164	67	352
206	83	439

UP. 02. SFT - 45° ELBOW

45° adaptor elbow

- Female solvent socket & BSP female thread
- Metric series

Codo 45° mixto

- Encolar hembra y roscar hembra BSP
- Serie métrica

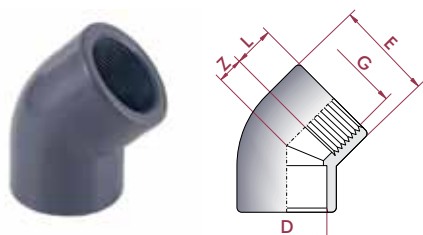

D x G	DN	PN	REF.	CODE
20 x 1/2"	15	10	05 02 420	01762
25 x 3/4"	20	10	05 02 425	01763
32 x 1"	25	10	05 02 432	01764
40 x 1 1/4"	32	10	05 02 440	01765
50 x 1 1/2"	40	10	05 02 450	01766
63 x 2"	50	10	05 02 463	01767
75 x 2 1/2"	65	10	05 02 475 [*]	22599
90 x 3"	80	10	05 02 490 [*]	22600
110 x 4"	100	10	05 02 510 [*]	22601

L	Z	E
14	5	28
16	6	34
19	8	43
20	10	54
20	12	63
24	14	78
44	18	89
51	21	106
61	25	128

* Distributed product
* Producto comercializado

¹ AFNOR
² KIWA
³ AENOR

UP. 02. SFTR - 45° REINFORCED ELBOW

45° adaptor reinforced elbow

- Female solvent socket & BSP female thread
- Reinforcement in stainless steel
- Metric series

Codo 45° mixto reforzado

- Encolar hembra y roscar hembra BSP
- Refuerzo en acero inoxidable
- Serie métrica

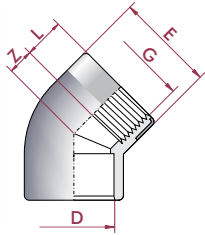

D x G	DN	PN	REF.	CODE
20 x 1/2"	15	16	05 02 820	01774
25 x 3/4"	20	16	05 02 825	01775
32 x 1"	25	16	05 02 832	01776
40 x 1 1/4"	32	16	05 02 840	01777
50 x 1 1/2"	40	16	05 02 850	01778
63 x 2"	50	16	05 02 863	01779

L	Z	E
14	5	28
16	6	34
19	8	43
20	10	54
20	12	63
24	14	78

UP. 02. FT - 45° ELBOW

45° elbow

- BSP female thread

Codo 45°

- Roscar hembra BSP

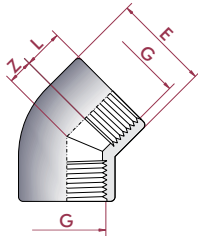

G	DN	PN	REF.	CODE
1/2"	15	10	05 02 620	01768
3/4"	20	10	05 02 625	01769
1"	25	10	05 02 632	01770
1 1/4"	32	10	05 02 640	01771
1 1/2"	40	10	05 02 650	01772
2"	50	10	05 02 663	01773
2 1/2"	65	10	05 02 675 *	22590
3"	80	10	05 02 690 *	22591
4"	100	10	05 02 710 *	22592

L	Z	E
14	5	28
16	6	34
19	8	43
20	10	54
20	12	63
24	14	78
30	32	89
34	39	106
40	47	129

UP. 30. SFG - 45° REDUCING ELBOW

45° reducing elbow

- Female and male solvent socket
- Metric series

Codo 45° reducido

- Encolar hembra y macho
- Serie métrica

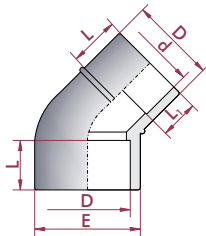

D x D - d	DN	PN	REF.	CODE
50 x 50 - 40	40 x 32	16	05 30 050	02241
63 x 63 - 50	50 x 40	16	05 30 063	02242

L	L ₁	E
31	26	61
38	31	76

* Distributed product

* Producto comercializado

PVC-U BEND
CURVAS PVC-U

UP. 35. SF - 45° BEND

45° bend

- Female solvent socket
- Metric series

Curva 45°

- Encolar hembra
- Serie métrica

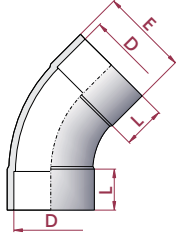

D	DN	PN	REF.	CODE
315	300	4	05 35 315 *	05348
400	353	4	05 35 400 *	05349

L	E
165	348
206	432

UP. 08. SF - 90° BEND

90° bend

- Female solvent socket
- Metric series

Curva 90°

- Encolar hembra
- Serie métrica

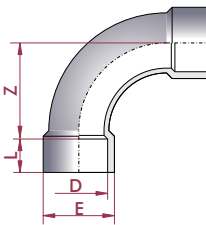

D	DN	PN	REF.	CODE
20	15	16	05 08 020 ³	01967
25	20	16	05 08 025 ³	01968
32	25	16	05 08 032 ³	01969
40	32	16	05 08 040 ³	01970
50	40	16	05 08 050 ³	01971
63	50	16	05 08 063 ³	01972
75	65	16	05 08 075 ³	01973
90	80	16	05 08 090 ³	05331
110	100	16	05 08 110 *	05332
125	110	10	05 08 125 *	05333
140	125	10	05 08 140 *	05334
160	150	10	05 08 160 *	05335
200	175	4	05 08 200 *	05336
225	200	4	05 08 225 *	05337
250	225	4	05 08 250 *	05338
315	300	4	05 08 315 *	05339
400	353	4	05 08 400 *	05340

L	Z	E
16	40	27
19	50	33
22	64	41
26	80	50
31	100	61
38	126	76
44	150	90
51	180	113
61	220	132
69	186	150
76	166	164
86	194	186
106	284	223
119	296	251
131	334	275
165	520	348
206	614	432

* Distributed product
* Producto comercializado

³ AENOR

PVC-U TEES

TÉS PVC-U

UP. 03. SF - 90° TEE

90° tee

- Female solvent socket
- Metric series

Té 90°

- Encolar hembra
- Serie métrica

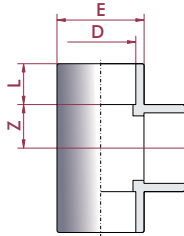

D	DN	PN	REF.	CODE
16	10	16	05 03 016 ³	16308
20	15	16	05 03 020 ¹²³	01780
25	20	16	05 03 025 ¹²³	01781
32	25	16	05 03 032 ¹²³	01782
40	32	16	05 03 040 ²³	01783
50	40	16	05 03 050 ¹²³	01784
63	50	16	05 03 063 ¹²³	01785
75	65	16	05 03 075 ²³	01786
90	80	16	05 03 090 ²³	01787
110	100	16	05 03 110 ³	01788
125	110	16	05 03 125 ³	01789
140	125	16	05 03 140 ³	01790
160	150	10	05 03 160 ³	01791
200	175	10	05 03 200 ³	01792
225	200	10	05 03 225 ³	01793
250	225	10	05 03 250 ³	01794
315	300	10	05 03 315 ³	01795
400	325	4	05 03 400 [*]	05328

L	Z	E
14	9	22
16	11	27
19	14	33
22	17	41
26	21	50
31	26	63
38	33	78
44	39	90
51	46	108
61	56	131
69	64	148
76	71	164
86	81	186
106	101	228
119	114	255
131	126	284
164	159	356
206	280	432

UP. 03. SFT - 90° TEE

90° adaptor tee

- Female solvent socket & BSP female thread
- Metric series

Té 90° mixta

- Encolar hembra y roscar hembra BSP
- Serie métrica

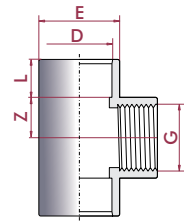

D x G	DN	PN	REF.	CODE
20 x 1/2"	15	10	05 03 420	01796
25 x 3/4"	20	10	05 03 425	01797
32 x 1"	25	10	05 03 432	01798
40 x 1 1/4"	32	10	05 03 440	01799
50 x 1 1/2"	40	10	05 03 450	01800
63 x 2"	50	10	05 03 463	01801
75 x 2 1/2"	65	10	05 03 475 [*]	22602
90 x 3"	80	10	05 03 490 [*]	22603
110 x 4"	100	10	05 03 510 [*]	22604

L	Z	E
14	11	28
16	14	34
19	17	43
20	21	54
20	26	63
24	33	78
44	39	89
51	47	106
61	57	129

UP. 03. SFTR - 90° REINFORCED TEE

90° adaptor reinforced tee

- Female solvent socket & BSP female thread
- Reinforcement in stainless steel
- Metric series

Té 90° mixta reforzada

- Encolar hembra y roscar hembra BSP
- Refuerzo en acero inoxidable
- Serie métrica

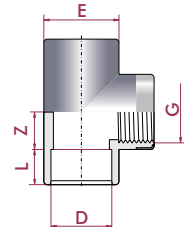

D x G	DN	PN	REF.	CODE
20 x 1/2"	15	16	05 03 820	01808
25 x 3/4"	20	16	05 03 825	01809
32 x 1"	25	16	05 03 832	01810
40 x 1 1/4"	32	16	05 03 840	01811
50 x 1 1/2"	40	16	05 03 850	01812
63 x 2"	50	16	05 03 863	01813

L	Z	E
14	11	28
16	14	34
19	17	43
20	21	54
20	26	63
24	33	78

UP. 03. FT - 90° TEE

90° tee

- BSP female thread

Té 90°

- Roscar hembra BSP

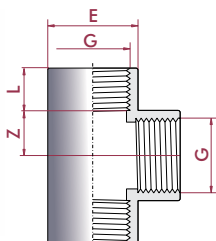

G	DN	PN	REF.	CODE
1/2"	15	10	05 03 620	01802
3/4"	20	10	05 03 625	01803
1"	25	10	05 03 632	01804
1 1/4"	32	10	05 03 640	01805
1 1/2"	40	10	05 03 650	01806
2"	50	10	05 03 663	01807
2 1/2"	65	10	05 03 675 [*]	22593
3"	80	10	05 03 690 [*]	22594
4"	100	10	05 03 710 [*]	22595

L	Z	E
14	11	28
16	14	34
19	17	43
20	21	54
20	26	63
24	33	78
30	53	89
34	65	106
40	79	129

* Distributed product
* Producto comercializado

¹ AFNOR
² KIWA
³ AENOR

UP. 04. SFG - 90° REDUCING TEE

90° reducing tee

- Female solvent socket
- Metric series

Té 90° reducida

- Encolar hembra
- Serie métrica

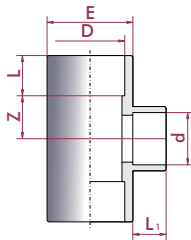

D x d	DN	PN	REF.	CODE
25 x 20	20 - 15	16	05 04 025	01814
32 x 25	25 - 20	16	05 04 032	01815
32 x 20	25 - 15	16	05 04 033	01816
40 x 32	32 - 25	16	05 04 040	01817
40 x 25	32 - 20	16	05 04 041	01818
40 x 20	32 - 15	16	05 04 042	01819
50 x 40	40 - 32	16	05 04 050	01820
50 x 32	40 - 25	16	05 04 051	01821
50 x 25	40 - 20	16	05 04 052	01822
50 x 20	40 - 15	16	05 04 053	01823
63 x 50	50 - 40	16	05 04 063	01824
63 x 40	50 - 32	16	05 04 064	01825
63 x 32	50 - 25	16	05 04 065	01826
63 x 25	50 - 20	16	05 04 066	01827
63 x 20	50 - 15	16	05 04 067	01828
75 x 63	65 - 50	16	05 04 075	01829
75 x 50	65 - 40	16	05 04 076	01830
75 x 40	65 - 32	16	05 04 077	01831
75 x 32	65 - 25	16	05 04 078	01832
90 x 75	80 - 65	16	05 04 090	01833
90 x 63	80 - 50	16	05 04 091	01834
90 x 50	80 - 40	16	05 04 092	01835
90 x 40	80 - 32	16	05 04 093	01836
110 x 90	100 - 80	16	05 04 110	01837
110 x 75	100 - 65	16	05 04 111	01838
110 x 63	100 - 50	16	05 04 112	01839
110 x 50	100 - 40	16	05 04 113	01840
125 x 110	110 - 100	16	05 04 125	01841
125 x 90	110 - 80	16	05 04 126	01842
125 x 75	110 - 65	16	05 04 127	01843
125 x 63	110 - 50	16	05 04 128	01844
140 x 125	125 - 110	16	05 04 140	01845
140 x 110	125 - 100	16	05 04 141	01846
140 x 90	125 - 80	16	05 04 142	01847
140 x 75	125 - 65	16	05 04 143	01848
160 x 140	150 - 125	10	05 04 160	07688
160 x 125	150 - 110	10	05 04 161	07689
160 x 110	150 - 100	10	05 04 162	07690
160 x 90	150 - 80	10	05 04 163	07691

L	L ₁	Z	E
19	16	14	33
22	19	17	41
22	16	17	41
26	22	21	50
26	19	21	50
26	16	21	50
31	26	26	61
31	22	26	61
31	19	26	61
31	16	26	61
38	31	33	76
38	26	33	76
38	22	33	76
38	19	33	76
38	16	33	76
44	38	39	90
44	31	39	90
44	26	39	90
44	22	39	90
51	44	46	108
51	38	46	108
51	31	46	108
51	26	46	108
61	51	56	131
61	44	56	131
61	38	56	131
61	31	56	131
69	61	64	149
69	51	64	149
69	44	64	149
69	38	64	149
76	69	71	162
76	61	71	162
76	51	71	162
76	44	71	162
86	76	81	186
86	69	81	186
86	61	81	186
86	51	81	186

UP. 04. SFTG - 90° REDUCING TEE
90° reducing tee

- Female solvent socket & BSP female thread
- Metric series

Té 90° reducida

- Encolar hembra y roscar hembra BSP
- Serie métrica

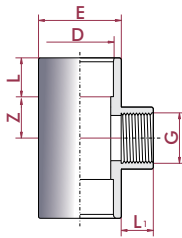

D x G	DN	PN	REF.	CODE
25 x 1/2"	20 - 15	10	05 04 425	01849
32 x 3/4"	25 - 20	10	05 04 432	01850
32 x 1/2"	25 - 15	10	05 04 433	01851
40 x 1"	32 - 25	10	05 04 440	01852
40 x 3/4"	32 - 20	10	05 04 441	01853
40 x 1/2"	32 - 15	10	05 04 442	01854
50 x 1 1/4"	40 - 32	10	05 04 450	01855
50 x 1"	40 - 25	10	05 04 451	01856
50 x 3/4"	40 - 20	10	05 04 452	01857
50 x 1/2"	40 - 15	10	05 04 453	01858
63 x 1 1/2"	50 - 40	10	05 04 463	01859
63 x 1 1/4"	50 - 32	10	05 04 464	01860
63 x 1"	50 - 25	10	05 04 465	01861
63 x 3/4"	50 - 20	10	05 04 466	01862
63 x 1/2"	50 - 15	10	05 04 467	01863
75 x 2"	65 - 50	10	05 04 475	01864
75 x 1 1/2"	65 - 40	10	05 04 476	01865
75 x 1 1/4"	65 - 32	10	05 04 477	01866
75 x 1"	65 - 25	10	05 04 478	01867
90 x 2 1/2"	80 - 65	10	05 04 490	01868
90 x 2"	80 - 50	10	05 04 491	01869
90 x 1 1/2"	80 - 40	10	05 04 492	01870
90 x 1 1/4"	80 - 32	10	05 04 493	01871

L	L ₁	Z	E
19	14	14	33
22	16	17	41
22	14	17	41
26	19	21	50
26	16	21	50
26	14	21	50
31	20	26	61
31	19	26	61
31	16	26	61
31	14	26	61
38	20	33	76
38	20	33	76
38	19	33	76
38	16	33	76
38	14	33	76
44	24	39	90
44	20	39	90
44	20	39	90
44	19	39	90
51	44	46	108
51	24	46	108
51	20	46	108
51	20	46	108

UP. 36. SF - 45° TEE
45° tee

- Female solvent socket
- Metric series

Té 45°

- Encolar hembra
- Serie métrica

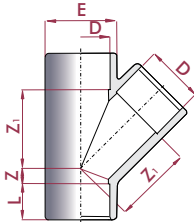

D	DN	PN	REF.	CODE
20	15	16	05 36 020 *	22583
25	20	16	05 36 025 *	22584
32	25	16	05 36 032 *	22585
40	32	16	05 36 040	22586
50	40	10	05 36 050 ³	20155
63	50	10	05 36 063 ³	20156
75	65	10	05 36 075 *	32804
90	80	10	05 36 090 *	32805
110	100	10	05 36 110 *	32806

L	Z	Z ₁	E
16	7	29	28
19	7	36	34
22	8	44	42
26	10	54	51
31	13	67	61
38	15	83	76
44	18	101	91
51	20	122	106
61	27	149	133

**PVC-U CROSSES
CRUCES PVC-U**
UP. 28. SF - CROSS
Cross

- Female solvent socket
- Metric series

Cruz

- Encolar hembra
- Serie métrica

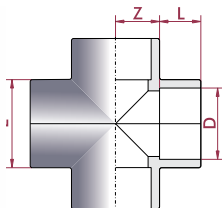

D	DN	PN	REF.	CODE
20	15	16	05 28 020	20143
25	20	16	05 28 025	20144
32	25	16	05 28 032	20145
40	32	16	05 28 040	20146
50	40	16	05 28 050	02235
63	50	16	05 28 063	02236
75	65	16	05 28 075 *	27958
90	80	16	05 28 090 *	22581
110	100	16	05 28 110 *	22582

L	Z	E
16	11	29
19	14	35
22	17	43
26	21	52
31	26	63
38	33	79
42	39	92
51	46	106
61	56	130

* Distributed product
* Producto comercializado

³ AENOR

PVC-U SOCKETS MANGUITOS UNIÓN PVC-U

UP. 05. SF - SOCKET

Socket

- Female solvent socket
- Metric series

Manguito unión

- Encolar hembra
- Serie métrica

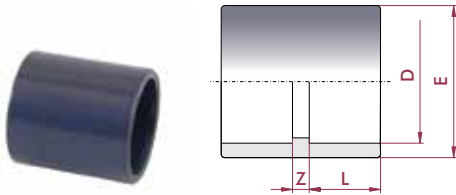

D	DN	PN	REF.	CODE
16	10	16	05 05 016 ³	16309
20	15	16	05 05 020 ¹²³	01872
25	20	16	05 05 025 ¹²³	01873
32	25	16	05 05 032 ¹²³	01874
40	32	16	05 05 040 ¹²³	01875
50	40	16	05 05 050 ¹²³	01876
63	50	16	05 05 063 ¹²³	01877
75	65	16	05 05 075 ¹²³	01878
90	80	16	05 05 090 ¹²³	01879
110	100	16	05 05 110 ¹³	01880
125	110	16	05 05 125 ¹³	01881
140	125	16	05 05 140 ¹³	01882
160	150	10	05 05 160 ¹³	01883
200	175	10	05 05 200 ³	01884
225	200	10	05 05 225 ³	01885
250	225	10	05 05 250 ³	01886
315	300	10	05 05 315 ³	01887
400	375	6	05 05 400*	05329

L	Z	E
14	3	22
16	3	27
19	3	33
22	3	41
26	3	50
31	3	61
38	3	75
44	4	90
51	5	108
61	6	129
69	7	148
76	9	164
86	9	180
106	10	225
119	10	252
131	12	280
164	12	352
206	12	432

UP. 05. SFT - SOCKET

Adaptor socket

- Female solvent socket & BSP female thread
- Metric series

Manguito unión mixto

- Encolar hembra y roscar hembra BSP
- Serie métrica

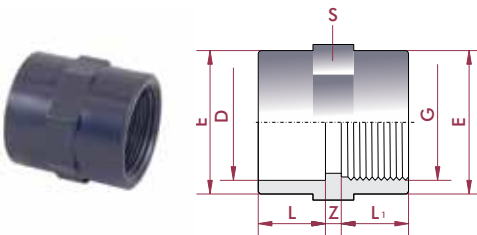

D x G	DN	PN	REF.	CODE
16 x 3/8"	12	10	05 05 416	01888
20 x 1/2"	15	10	05 05 420	01889
25 x 3/4"	20	10	05 05 425	01890
32 x 1"	25	10	05 05 432	01891
40 x 1 1/4"	32	10	05 05 440	01892
50 x 1 1/2"	40	10	05 05 450	01893
63 x 2"	50	10	05 05 463	01894
75 x 2 1/2"	65	10	05 05 475	01895
90 x 3"	80	10	05 05 490	01896
110 x 4"	90	10	05 05 510	01897

L	L ₁	Z	E	S
14	14	3	22	22
16	14	3	28	27
19	16	3	34	33
22	19	3	43	41
26	20	3	54	50
31	20	3	63	61
38	24	3	78	75
44	44	4	90	90
51	51	6	108	108
61	61	6	135	135

UP. 05. SFTR - SOCKET REINFORCED

Adaptor socket reinforced

- Female solvent socket & BSP female thread
- Reinforcement in stainless steel
- Metric series

Manguito unión mixto reforzado

- Encolar hembra y roscar hembra BSP
- Refuerzo en acero inoxidable
- Serie métrica

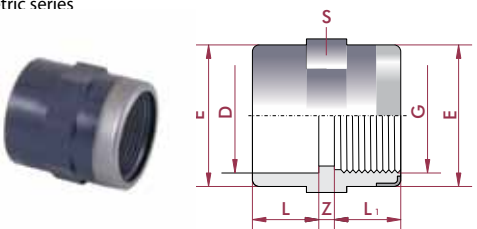

D x G	DN	PN	REF.	CODE
20 x 1/2"	15	16	05 05 820	01908
25 x 3/4"	20	16	05 05 825	01909
32 x 1"	25	16	05 05 832	01910
40 x 1 1/4"	32	16	05 05 840	01911
50 x 1 1/2"	40	16	05 05 850	01912
63 x 2"	50	16	05 05 863	01913

L	L ₁	Z	E	S
16	14	3	28	27
19	16	3	34	33
22	19	3	43	41
26	20	3	54	50
31	20	3	63	61
38	24	3	78	75

UP. 05. FT - SOCKET

Threaded adaptor socket

- BSP female thread

Manguito unión doble rosca

- Roscar hembra BSP

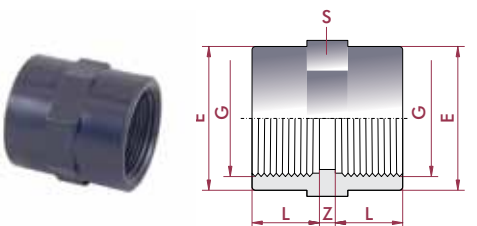

G	DN	PN	REF.	CODE
3/8"	10	10	05 05 616	01898
1/2"	15	10	05 05 620	01899
3/4"	20	10	05 05 625	01900
1"	25	10	05 05 632	01901
1 1/4"	32	10	05 05 640	01902
1 1/2"	40	10	05 05 650	01903
2"	50	10	05 05 663	01904
2 1/2"	65	10	05 05 675	01905
3"	80	10	05 05 690	01906
4"	100	10	05 05 710	01907

L	Z	E	S
14	3	22	22
14	3	27	28
16	3	33	34
19	3	41	43
20	3	50	54
20	3	61	63
24	3	75	78
44	4	90	90
51	6	108	108
61	6	135	135

* Distributed product
* Producto comercializado

¹ AFNOR
² KIWA
³ AENOR

PVC-U REDUCERS REDUCCIONES PVC-U

UP. 06. SMF - REDUCING BUSH

Reducing bush

- Male x female solvent socket
- Metric series

Casquillo reducción

- Encolar macho x hembra
- Serie métrica

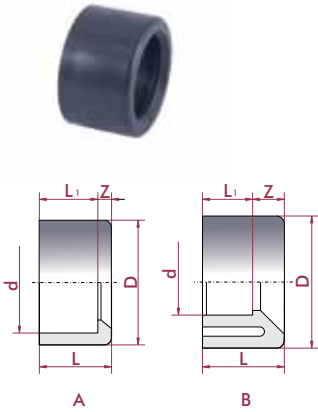

D x d	DN	PN	REF.	CODE	L	L ₁	Z	Mod.
20 x 16	10	16	05 06 020 ³	01914	16	14	2	A
25 x 20	15	16	05 06 025 ²³	01915	19	16	3	A
32 x 25	20	16	05 06 032 ²³	01916	22	19	3	A
32 x 20	15	16	05 06 033 ³	01917	22	16	6	A
40 x 32	25	16	05 06 040 ²³	01918	26	22	4	A
40 x 25	20	16	05 06 041 ³	01919	26	19	7	A
40 x 20	15	16	05 06 042 ³	01920	26	16	10	B
50 x 40	32	16	05 06 050 ²³	01921	31	26	5	A
50 x 32	25	16	05 06 051 ³	01922	31	22	9	B
50 x 25	20	16	05 06 052 ³	01923	31	19	12	B
50 x 20	15	16	05 06 053 ³	01924	31	16	15	B
63 x 50	40	16	05 06 063 ²³	01925	38	31	7	A
63 x 40	32	16	05 06 064 ³	01926	38	26	12	B
63 x 32	25	16	05 06 065 ³	01927	38	22	16	B
75 x 63	50	16	05 06 075 ²³	01928	44	38	6	A
75 x 50	40	16	05 06 076 ³	18685	44	31	13	B
75 x 40	32	16	05 06 077 ³	18686	44	26	18	B
90 x 75	65	16	05 06 090 ²³	01929	51	44	7	A
90 x 63	50	16	05 06 091 ³	18687	51	38	13	B
90 x 50	40	16	05 06 092 ³	18688	51	31	20	B
110 x 90	80	16	05 06 110 ³	01930	61	51	10	A
110 x 75	65	16	05 06 111 ³	18689	61	44	17	B
110 x 63	50	16	05 06 112 ³	18690	61	38	23	B
125 x 110	100	16	05 06 125 ³	01931	69	61	8	A
125 x 90	80	16	05 06 126 ³	18691	69	51	18	B
125 x 75	65	16	05 06 127 ³	20142	69	44	25	B
140 x 125	110	16	05 06 140 ³	01932	76	69	8	A
140 x 110	100	16	05 06 141 ³	18692	76	61	15	B
160 x 140	125	10	05 06 160 ³	01933	86	76	10	A
160 x 110	100	10	05 06 162 ³	18693	86	61	25	B
200 x 180	160	10	05 06 199 ³	01934	106	96	10	A
200 x 160	150	10	05 06 200 ³	01935	106	86	20	B
225 x 200	175	10	05 06 225 ³	01936	119	106	13	A
225 x 160	150	10	05 06 226 ³	01937	119	86	33	B
250 x 225	200	10	05 06 250 ³	01938	131	119	12	A
250 x 200	175	10	05 06 251 ³	01939	131	106	25	B
315 x 280	250	6	05 06 315	10093				
315 x 250	225	6	05 06 316 [*]	01940	164	131	33	B
315 x 225	200	6	05 06 317 [*]	01941	164	119	45	B
400 x 315	300	6	05 06 400 [*]	05330	206	163	42	B

* Distributed product

* Producto comercializado

¹ AFNOR

² KIWA

³ AENOR

UP. 09. SMF - CONICAL REDUCER

Conical reducer

- Male x female solvent socket
- Metric series

Reducción cónica

- Encolar macho x hembra
- Serie métrica

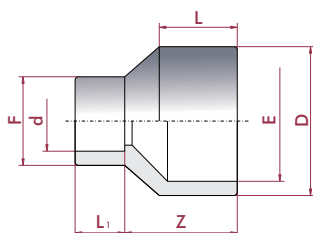

D-E x d	DN	PN	DN	CODE
32-25 x 25	20	16	05 09 032 ³	01974
32-25 x 20	15	16	05 09 033 ³	01975
40-32 x 32	25	16	05 09 040 ³	01976
40-32 x 25	20	16	05 09 041 ³	01977
40-32 x 20	15	16	05 09 042 ³	01978
50-40 x 40	32	16	05 09 050 ³	01979
50-40 x 32	25	16	05 09 051 ³	01980
50-40 x 25	20	16	05 09 052 ³	01981
50-40 x 20	15	16	05 09 053 ³	01982
63-50 x 50	40	16	05 09 063 ³	01983
63-50 x 40	32	16	05 09 064 ³	01984
63-50 x 32	25	16	05 09 065 ³	01985
63-50 x 25	20	16	05 09 066 ³	01986
63-50 x 20	15	16	05 09 067 ³	01987
75-63 x 63	50	16	05 09 075 ³	01988
75-63 x 50	40	16	05 09 076 ³	01989
75-63 x 40	32	16	05 09 077 ³	01990
75-63 x 32	25	16	05 09 078 ³	01991
90-75 x 75	65	16	05 09 090 ³	01992
90-75 x 63	50	16	05 09 091 ³	01993
90-75 x 50	40	16	05 09 092 ³	01994
90-75 x 40	32	16	05 09 093 ³	01995
110-90 x 90	80	16	05 09 110 ³	01996
110-90 x 75	65	16	05 09 111 ³	01997
110-90 x 63	50	16	05 09 112 ³	01998
110-90 x 50	40	16	05 09 113 ³	01999
125-110 x 90	80	16	05 09 126 ³	02000
125-110 x 75	65	16	05 09 127 ³	02001
125-110 x 63	50	16	05 09 128 ³	02002
140-125 x 110	100	16	05 09 141 ³	02003
140-125 x 90	80	16	05 09 142 ³	02004
140-125 x 75	65	16	05 09 143 ³	02005
160-140 x 125	110	10	05 09 161 ¹³	02006
160-140 x 110	100	10	05 09 162 ¹³	02007
160-140 x 90	80	10	05 09 163 ³	02008
200-180 x 140	125	10	05 09 202	02009
200-180 x 125	110	10	05 09 203	02010
200-180 x 110	100	10	05 09 204	02011
225-200 x 160	150	10	05 09 227	02012
225-200 x 140	125	10	05 09 228	02013
225-200 x 125	110	10	05 09 229	02014
250-225 x 200	175	10	05 09 251	02015
250-225 x 160	150	10	05 09 253	02016
250-225 x 140	125	10	05 09 254	02017
315-280 x 200	175	6	05 09 318 *	02018
315-280 x 160	150	6	05 09 320 *	02019

L ₁	Z	F
19	30	33
16	30	27
22	36	38
19	36	33
16	36	27
26	44	48
22	44	41
19	44	33
16	44	27
31	54	61
26	54	50
22	54	41
19	54	33
16	54	27
38	62	73
31	62	61
26	62	50
22	62	41
44	74	87
38	74	75
31	74	61
26	74	50
51	88	105
44	88	90
38	88	75
31	88	61
51	100	105
44	100	90
38	100	75
61	111	130
51	111	105
44	111	90
69	126	148
61	126	130
51	126	105
76	154	157
69	154	140
61	154	130
86	171	180
76	171	160
69	171	140
106	194	225
86	194	180
76	194	157
106	233	225
86	233	180

UP. 09. SF - EXCENTRIC CONICAL REDUCER

Excentric conical reducer

- Female solvent socket
- Metric series

Reducción cónica excéntrica

- Encolar hembra
- Serie métrica

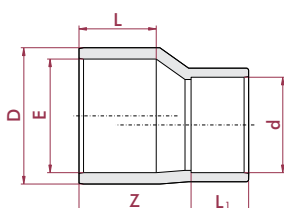

D-E x d	DN	PN	REF.	CODE
90 - 75 x 63	50	16	05 09 691	09030

L	L ₁	Z
51	38	74

* Distributed product
* Producto comercializado

¹ AFNOR
² KIWA
³ AENOR

PVC-U CAPS TAPONES PVC-U

UP. 07. SF - CAP

Cap

- Female solvent socket
- Metric series

Tapón

- Encolar hembra
- Serie métrica

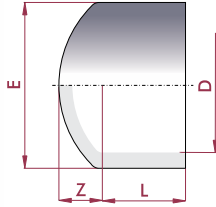

D	DN	PN	REF.	CODE
16	10	16	05 07 016	01942
20	15	16	05 07 020 ²	01943
25	20	16	05 07 025 ²	01944
32	25	16	05 07 032 ²	01945
40	32	16	05 07 040 ²	01946
50	40	16	05 07 050 ²	01947
63	50	16	05 07 063 ²	01948
75	65	16	05 07 075 ²	01949
90	80	16	05 07 090 ²	01950
110	100	16	05 07 110	01951
125	110	16	05 07 125	01952
140	125	16	05 07 140	01953
160	150	10	05 07 160	01954
200	175	10	05 07 200	01955
225	200	10	05 07 225	01956
250	225	10	05 07 250	15776
315	300	10	05 07 315	15777

L	Z	E
14	7	22
16	8	25
19	9	32
22	10	40
26	12	50
31	15	63
38	17	75
44	19	90
51	23	110
61	28	131
69	32	148
76	36	163
86	40	185
106	46	224
119	50	252
131	60	282
164	70	357

UP. 07. FT - CAP

Cap

- BSP female thread

Tapón

- Roscar hembra BSP

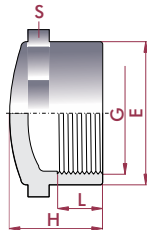

G	DN	PN	REF.	CODE
3/8"	10	10	10	10
1/2"	15	10	15	10
3/4"	20	10	20	10
1"	25	10	25	10
1 1/4"	32	10	32	10
1 1/2"	40	10	40	10
2"	50	10	50	10
2 1/2"	65	10	65	10
3"	80	10	80	10
4"	100	10	100	10

L	E	H	S
14	24	20	24
14	27	23	27
16	33	28	33
19	41	33	41
20	50	36	50
20	61	43	61
24	75	50	75
44	90	64	90
51	108	76	108
61	135	91	135

UP. 19. MT - PLUG

Plug

- BSP male thread

Tapón

- Roscar macho BSP

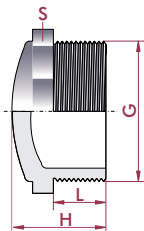

G	DN	PN	REF.	CODE
1/4"	8	10	05 19 612	02121
3/8"	10	10	05 19 616	02122
1/2"	15	10	05 19 620	02123
3/4"	20	10	05 19 625	02124
1"	25	10	05 19 632	02125
1 1/4"	32	10	05 19 640	02126
1 1/2"	40	10	05 19 650	02127
2"	50	10	05 19 663	02128
2 1/2"	65	10	05 19 675	02129
3"	80	10	05 19 690	02130
4"	100	10	05 19 710	02131

L	H	S
10	18	12
10	22	20
14	27	27
16	30	32
19	34	36
21	36	46
21	37	55
26	42	65
30	50	80
33	59	93
38	68	115

¹ AFNOR
² KIWA
³ AENOR

PVC-U NIPPLES MACHONES PVC-U

UP. 15. SFMT - ADAPTOR NIPPLE

Adaptor nipple

- Female solvent socket & BSP male thread
- Metric series

Machón mixto

- Encolar hembra y roscar macho BSP
- Serie métrica

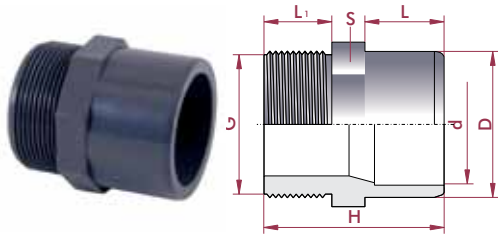

D - d x G	DN	PN	REF.	CODE
16 - 12 x 3/8"	12	10	05 15 416	02073
20 - 16 x 1/2"	15	10	05 15 420	02074
20 - 16 x 3/4"	12	10	05 15 421	02075
25 - 20 x 3/4"	20	10	05 15 425	02076
25 - 20 x 1/2"	15	10	05 15 426	02077
25 - 20 x 3/8"	12	10	05 15 427	02078
32 - 25 x 1"	25	10	05 15 432	02079
32 - 25 x 3/4"	20	10	05 15 433	02080
32 - 25 x 1/2"	15	10	05 15 434	02081
40 - 32 x 1 1/4"	32	10	05 15 440	02082
40 - 32 x 1"	25	10	05 15 441	02083
40 - 32 x 3/4"	20	10	05 15 442	02084
50 - 40 x 1 1/2"	40	10	05 15 450	02085
50 - 40 x 1 1/4"	32	10	05 15 451	02086
50 - 40 x 1"	25	10	05 15 452	02087
63 - 50 x 2"	50	10	05 15 463	02088
63 - 50 x 1 1/2"	40	10	05 15 464	02089
63 - 50 x 1 1/4"	32	10	05 15 465	02090
75 - 63 x 2 1/2"	65	10	05 15 475	02091
75 - 63 x 2"	50	10	05 15 476	02092
75 - 63 x 1 1/2"	40	10	05 15 477	02093
90 - 75 x 3"	80	10	05 15 490	02094
90 - 75 x 2 1/2"	65	10	05 15 491	02095
90 - 75 x 2"	50	10	05 15 492	02096
110 - 90 x 4"	100	10	05 15 510	02097
110 - 90 x 3"	80	10	05 15 511	02098
110 - 90 x 2 1/2"	65	10	05 15 512	02099

L	L ₁	H	S
14	11	35	24
16	14	42	27
16	11	39	27
19	16	47	32
19	14	45	32
19	11	42	32
22	19	54	36
22	16	51	36
22	14	49	36
26	21	60	46
26	19	58	46
26	16	55	46
31	25	70	55
31	21	66	55
31	19	64	55
38	25	78	65
38	21	73	65
38	21	73	65
44	30	89	78
44	25	84	78
44	21	80	78
51	33	99	93
51	30	96	93
51	25	91	93
61	40	116	120
61	33	109	120
61	30	106	120

UP. 16. SFMT - ADAPTOR NIPPLE

Adaptor nipple

- Female solvent socket x BSP male thread
- Metric series

Manguito adaptación

- Encolar hembra x roscar macho BSP
- Serie métrica

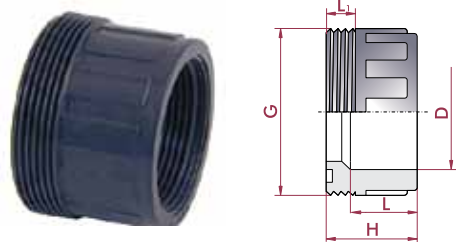

D x G	DN	PN	REF.	CODE
50 x 2"	40	10	05 16 450	02100
63 x 2 1/2"	50	10	05 16 463	02101

L	L ₁	H
31	16	52
38	17	62

UP. 17. SFMT - ADAPTOR BUSH

Adaptor bush

- Female solvent socket x BSP male threaded
- Metric series

Terminal rosca macho

- Encolar hembra x roscar macho BSP
- Serie métrica

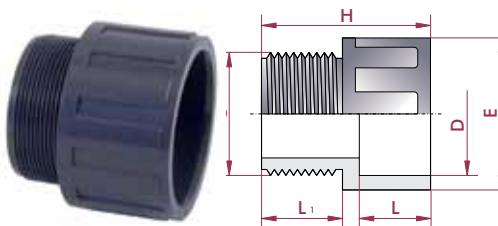

D x G	DN	PN	REF.	CODE
20 x 1/2"	15	10	05 17 420	02102
25 x 3/4"	20	10	05 17 425	02103
32 x 1"	25	10	05 17 432	02104
40 x 1 1/4"	32	10	05 17 440	02105
50 x 1 1/2"	40	10	05 17 450	02106
63 x 2"	50	10	05 17 463	02107
75 x 2 1/2"	65	10	05 17 475	02108
90 x 3"	80	10	05 17 490	02109
110 x 4"	100	10	05 17 510	02110

L	L ₁	E	H
16	14	28	38
19	16	34	42
22	19	41	50
26	21	51	55
31	22	62	65
38	27	77	75
44	30	90	85
51	33	108	98
61	40	131	115

UP. 18. MT - THREADED NIPPLE

Hexagon nipple

- BSP male thread

Machón doble rosca

- Roscar macho BSP

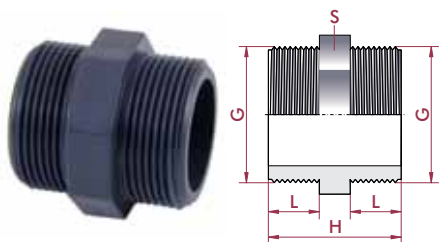

G	DN	PN	REF.	CODE
3/8"	10	10	05 18 616	02111
1/2"	15	10	05 18 620	02112
3/4"	20	10	05 18 625	02113
1"	25	10	05 18 632	02114
1 1/4"	32	10	05 18 640	02115
1 1/2"	40	10	05 18 650	02116
2"	50	10	05 18 663	02117
2 1/2"	65	10	05 18 675	02118
3"	80	10	05 18 690	02119
4"	100	10	05 18 710	02120

L	H	S
11	32	20
14	40	27
16	44	32
19	51	36
21	55	46
21	56	55
26	66	65
30	75	90
33	81	108
38	91	135

UP. 31. SFT - ADAPTOR NIPPLE

Adaptor nipple

- Female solvent socket & BSP female thread
- Metric series

Adaptador mixto

- Encolar hembra y roscar hembra BSP
- Serie métrica

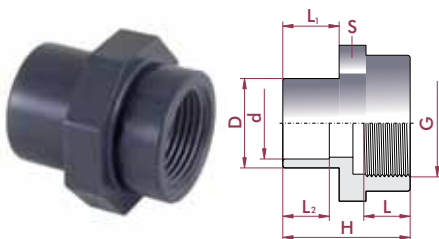

D - d x G	DN	PN	REF.	CODE
20 - 16 x 3/4"	16	10	05 31 420	02243
20 - 16 x 1/2"	16	10	05 31 421	02244
20 - 16 x 3/8"	12	10	05 31 422	02245
20 - 16 x 1/4"	12	10	05 31 423	02246
25 - 20 x 1"	20	10	05 31 425	02247
25 - 20 x 3/4"	20	10	05 31 426	02248
25 - 20 x 1/2"	16	10	05 31 427	02249
32 - 25 x 1 1/4"	25	10	05 31 432	02250
32 - 25 x 1"	25	10	05 31 433	02251
32 - 25 x 3/4"	20	10	05 31 434	02252
32 - 25 x 1/2"	16	10	05 31 435	24822
40 - 32 x 1 1/2"	32	10	05 31 440	02253
40 - 32 x 1 1/4"	32	10	05 31 441	02254
40 - 32 x 1"	25	10	05 31 442	02255
50 - 40 x 2"	40	10	05 31 450	02256
50 - 40 x 1 1/2"	40	10	05 31 451	02257
50 - 40 x 1 1/4"	32	10	05 31 452	02258
63 - 50 x 2 1/2"	50	10	05 31 463	02259
63 - 50 x 2"	50	10	05 31 464	02260
63 - 50 x 1 1/2"	40	10	05 31 465	02261
75 - 63 x 3"	50	10	05 31 475	02262
75 - 63 x 2 1/2"	65	10	05 31 476	02263
75 - 63 x 2"	50	10	05 31 477	02264
90 - 75 x 4"	65	10	05 31 490	02265
90 - 75 x 3"	65	10	05 31 491	02266
90 - 75 x 2 1/2"	65	10	05 31 492	02267
110 - 90 x 4"	80	10	05 31 511	02268
110 - 90 x 3"	80	10	05 31 512	02269

L	L ₁	L ₂	H	S
19	16	14	44	32
18	16	14	43	32
14	16	14	39	32
12	16	14	37	32
22	19	16	50	36
19	19	16	47	32
18	19	16	46	32
25	22	19	56	46
22	22	19	53	36
19	22	19	50	36
18	22	19	49	36
25	26	22	60	55
25	26	22	60	46
22	26	22	57	46
29	31	26	69	65
25	31	26	65	55
25	31	26	65	55
34	38	31	81	78
29	38	31	76	65
25	38	31	72	65
37	44	38	96	108
34	44	38	87	78
29	44	38	82	78
42	51	44	124	135
36	51	44	98	108
33	51	44	92	90
42	61	51	116	135
36	61	51	105	110

UP. 24. SF - SPIGOT CONNECTION

Spigot connection

- Solvent socket

Espiga conexión a PE lisa

- Encolar

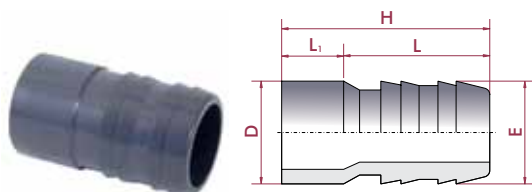

D x E	DN	PN	REF.	CODE
16 x 16	10	10	05 24 016	02200
20 x 18	15	10	05 24 018	02201
20 x 20	15	10	05 24 020	02202
25 x 25	20	10	05 24 025	02203
32 x 30	25	10	05 24 032	02204
40 x 40	32	10	05 24 040	02205
50 x 50	40	10	05 24 050	02206
50 x 38	40	10	05 24 051	02207
63 x 60	50	10	05 24 063	02208

H	L ₁	L	E
49	14	35	16
51	16	35	18
54	16	38	20
61	19	42	25
69	22	47	30
78	26	52	40
88	31	57	50
88	31	57	38
98	38	60	61

UP. 24. MT - SPIGOT CONNECTION

Spigot connection
• BSP male thread

Espiga conexión PE roscada
• Roscar macho BSP

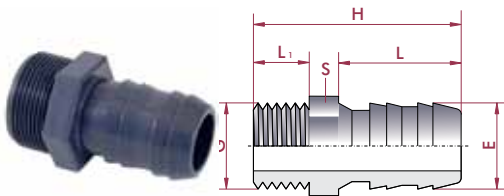

G x E	DN	PN	REF.	CODE
3/8" x 16	10	10	05 24 616	02217
1/2" x 18	15	10	05 24 618	02218
1/2" x 20	15	10	05 24 620	02219
3/4" x 25	20	10	05 24 625	02220
3/4" x 20	20	10	05 24 626	15763
1" x 30	25	10	05 24 632	02221
1" x 25	25	10	05 24 633	09031
1 1/4" x 40	32	10	05 24 640	02222
1 1/2" x 50	40	10	05 24 650	02223
1 1/2" x 38	40	10	05 24 651	02224
1 1/2" x 40	40	10	05 24 652	09032
2" x 60	50	10	05 24 663	02225

H	L ₁	S	L	E
54	11	35	18	16
58	15	35	22	18
60	15	38	22	20
67	17	42	27	25
62	17	36	27	20
78	21	47	36	30
78	21	47	36	25
84	22	52	46	40
89	22	57	50	50
89	22	57	50	38
89	22	57	50	40
100	26	60	65	61

UP. 32. MFT - THREADED REDUCER

Threaded reducer
• BSP male x female thread

Reducción roscada
• Roscar macho x hembra BSP

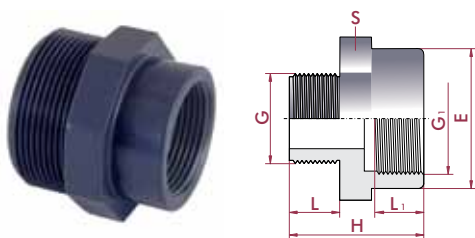

G x G ₁	DN	PN	REF.	CODE
3/8" x 1/2"	10	10	05 32 616	02270
1/2" x 3/4"	15	10	05 32 620	02271
1/2" x 3/8"	10	10	05 32 621	02272
3/4" x 1"	20	10	05 32 625	02273
3/4" x 1/2"	15	10	05 32 626	02274
3/4" x 3/8"	10	10	05 32 627	02275
1" x 1 1/4"	25	10	05 32 632	02276
1" x 3/4"	20	10	05 32 633	02277
1" x 1/2"	15	10	05 32 634	02278
1" x 3/8"	10	10	05 32 635	02279
1 1/4" x 1 1/2"	32	10	05 32 640	02280
1 1/4" x 1"	25	10	05 32 641	02281
1 1/4" x 3/4"	20	10	05 32 642	02282
1 1/4" x 1/2"	15	10	05 32 643	02283
1 1/2" x 2"	40	10	05 32 650	02284
1 1/2" x 1 1/4"	32	10	05 32 651	02285
1 1/2" x 1"	25	10	05 32 652	02286
1 1/2" x 3/4"	20	10	05 32 653	02287
2" x 2 1/2"	50	10	05 32 663	02288
2" x 1 1/2"	40	10	05 32 664	02289
2" x 1 1/4"	32	10	05 32 665	02290
2" x 1"	25	10	05 32 666	02291
2 1/2" x 3"	65	10	05 32 675	02292
2 1/2" x 2"	50	10	05 32 676	02293
2 1/2" x 1 1/2"	40	10	05 32 677	02294
2 1/2" x 1 1/4"	32	10	05 32 678	02295
3" x 4"	80	10	05 32 690	02296
3" x 2 1/2"	63	10	05 32 691	02297
3" x 2"	50	10	05 32 692	02298
3" x 1 1/2"	40	10	05 32 693	02299
4" x 3"	80	10	05 32 711	02300
4" x 2 1/2"	65	10	05 32 712	23001
4" x 2"	50	10	05 32 713	23002

L	L ₁	H	E	S
11	18	42	28	27
15	19	49	35	33
15	14	38	22	22
16	22	46	41	41
16	18	43	28	32
16	14	39	22	33
19	25	53	50	50
19	19	48	33	36
19	18	47	28	36
19	14	43	22	36
21	25	54	61	61
21	25	52	41	46
21	22	50	33	46
21	18	49	28	46
21	29	60	75	75
21	25	55	50	55
21	22	53	41	55
21	19	51	33	55
25	34	68	90	90
25	25	59	61	65
25	25	59	50	65
25	22	57	41	65
30	37	99	108	108
30	29	68	75	80
30	25	64	61	80
30	25	64	50	80
33	43	115	135	135
33	34	75	90	93
33	29	70	75	93
33	25	66	61	93
39	37	91	108	115
39	34	93	90	115
39	29	100	75	115

UP. 33. MT - THREADED REDUCER

Threaded reducer

• BSP male x male thread

Reducción roscada

• Roscar macho x macho BSP

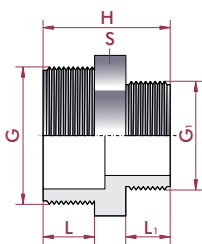

G x G ₁	DN	PN	REF.	CODE
1/2" x 3/8"	10	10	05 33 620	02303
3/4" x 1/2"	15	10	05 33 625	02304
3/4" x 3/8"	10	10	05 33 626	02305
1" x 3/4"	20	10	05 33 632	02306
1" x 1/2"	15	10	05 33 633	02307
1" x 3/8"	10	10	05 33 634	02308
1 1/4" x 1"	25	10	05 33 640	02309
1 1/4" x 3/4"	20	10	05 33 641	02310
1 1/4" x 1/2"	15	10	05 33 642	02311
1 1/2" x 1 1/4"	32	10	05 33 650	02312
1 1/2" x 1"	25	10	05 33 651	02313
1 1/2" x 3/4"	20	10	05 33 652	02314
2" x 1 1/2"	40	10	05 33 663	02315
2" x 1 1/4"	32	10	05 33 664	02316
2" x 1"	25	10	05 33 665	02317
2 1/2" x 2"	50	10	05 33 675	02318
2 1/2" x 1 1/2"	40	10	05 33 676	02319
2 1/2" x 1 1/4"	32	10	05 33 677	02320
3" x 2 1/2"	65	10	05 33 690	02321
3" x 2"	50	10	05 33 691	02322
3" x 1 1/2"	40	10	05 33 692	02323
4" x 3"	80	10	05 33 710	02324
4" x 2 1/2"	65	10	05 33 711	02325
4" x 2"	50	10	05 33 712	02326

L	L ₁	H	S
15	11	36	24
16	15	43	32
16	11	39	32
19	16	48	40
19	15	47	40
19	11	43	40
21	19	53	50
21	16	50	50
21	15	49	50
21	21	56	55
21	19	54	55
21	16	51	55
25	21	61	65
25	21	61	65
25	19	58	65
30	25	70	80
30	21	66	80
30	21	66	80
33	30	78	93
33	25	73	93
33	21	69	93
38	33	86	115
38	30	83	115
38	25	78	115

UP. 34. MFT - SHORT THREADED REDUCER

Short threaded reducer

• BSP male x female thread

Reducción roscada corta

• Roscar macho x hembra BSP

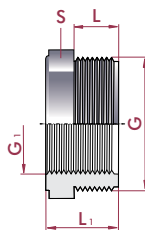

G x G ₁	DN	PN	REF.	CODE
1/2" x 1/4"	7	10	05 34 621	23087
3/4" x 1/2"	15	10	05 34 625	20147
3/4" x 1/4"	7	10	05 34 627	23088
3/4" x 1/8"	3	10	05 34 628	28081
1" x 3/4"	20	10	05 34 632	20148
1" x 1/4"	7	10	05 34 635	23089
1 1/4" x 1"	25	10	05 34 640	20149
1 1/2" x 1 1/4"	32	10	05 34 650	20150
2" x 1 1/2"	40	10	05 34 663	20151
2 1/2" x 2"	50	10	05 34 675	20152
3" x 2 1/2"	63	10	05 34 690	20153
4" x 3"	75	10	05 34 710	20154

L	L ₁	S
14	12	27
16	30	32
16	12	32
16	34	32
19	34	36
12	19	36
21	36	46
21	36	55
26	42	65
30	47	80
33	51	93
39	64	120

PVC-U RUBBER-RING JOINT FITTINGS

ACCESORIOS EN PVC-U CON JUNTA ELÁSTICA

FEATURES

Easy installation fittings, without effort or tools, thanks to its gaskets.
It is compulsory the use of an inner gasket to install it.
Designed to support earth movements or misalignments, ideally suited for underground installations.

It can absorb vibrations or pipe expansions due to its elasticity and flexibility.
To make the installation easier, it is very important to lubricate the gasket correctly.

- Material: PVC-U.
- Density: 1,4 g/cm³.
- Color: grey RAL 7011.
- Dimensions: from D63 to D315.
- Standards: dimensions and characteristics according to EN 1452.

CARACTERÍSTICAS

Accesorios fáciles de instalar, sin esfuerzo y sin herramientas gracias a las juntas.
Para su correcta instalación es necesaria la junta interior.
Está realizado para poder soportar movimientos de tierra y desalineaciones, ideal para instalaciones enterradas.

Gracias a su elasticidad y flexibilidad, absorbe mejor las vibraciones y la expansión del tubo.
Es muy importante una buena lubricación de la junta para instalar el tubo cómodamente.

- Material: PVC-U.
- Densidad: 1,4 g/cm³.
- Color: gris RAL 7011.
- Dimensiones: de D63 hasta D315.
- Normas: dimensiones y características según la norma EN 1452.

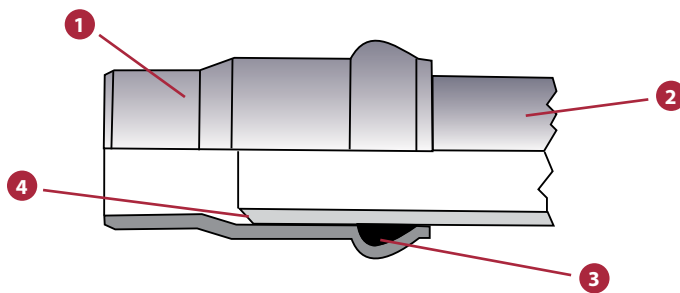

FIG.	Parts	Despiece	Material
1	Union socket	Manguito unión	PVC-U
2	Pipe	Tubería	-
3	Gasket	Junta	NBR
4	Chamfer to make an easier installation	Chaflán para una inserción más fácil	-

TECHNICAL CHARACTERISTICS

Working pressure at 20°C (73°F) water temperature:
 • D63 - D315: PN 10 (150 psi)

CARACTERÍSTICAS TÉCNICAS

Presión de servicio a 20°C (73°F) temperatura de agua:
 • D63 - D315: PN 10 (150 psi)

**PRESSURE / TEMPERATURE GRAPH
 DIAGRAMA PRESIÓN / TEMPERATURA**

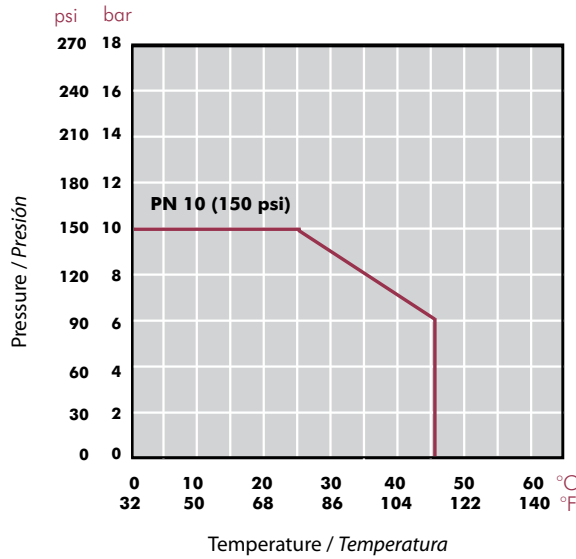

Life: 20 years
 Hydrostatic maximum pressure a component may withstand in continuous service (without overpressure)

Vida útil: 20 años
 Presión hidrostática máxima que un componente es capaz de soportar en servicio continuo (sin sobrepresión)

ASSEMBLY

A. Before assembling rubber ring fittings proceed as follows. In case of pipe end damaged: cut the pipe with a proper tool to obtain a square end.

MONTAJE

A. Antes de instalar los accesorios de junta elástica, proceda de la siguiente manera. En caso que el extremo del tubo está dañado: corte el tubo con una herramienta especial para obtener un corte recto perpendicular al eje.

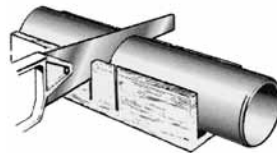

B. Chamfer the pipe with a special tool as shown in the following picture and table.

B. Chafane el tubo con una herramienta especial según lo mostrado en la imagen y el cuadro siguiente.

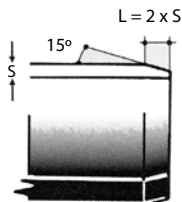

D (mm)	63	75	90	110	125	140	160	200
L (mm)	6,0	7,0	9,0	10,5	12,0	13,5	15,5	19,0

C. Clean carefully the external surface of the pipe and lubricate only with soapy water (do not use oil or grease).

C. Limpie cuidadosamente la superficie externa del tubo. Lubrique solamente con agua jabonosa (no utilice aceite o grasa).

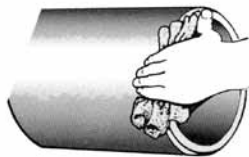

D. Clean carefully the socket seat in the fitting. Check gasket conditions. Introduce the sealing ring into its specific seat.

D. Limpie cuidadosamente el asiento de la junta del accesorio. Compruebe las condiciones de la junta. Introduzca la junta en su asiento específico.



E. Lubricate the internal surface of the rubber ring in the same way as the pipe.

E. Lubrique la superficie interna de la junta con un lubricante adecuado de la misma manera que el tubo.



F. Mark on the outside of the pipe the depth to be inserted into the socket of the fitting according to the lengths in the following table.

F. Marque en el exterior del tubo la profundidad a ser insertada en el accesorio según los longitudes del cuadro.

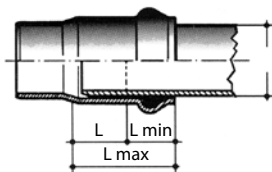

D (mm)	63	75	90	110	125	140	160	200
L max	94	104	109	115	124	133	139	169
L min	42	45	50	55	60	69	75	85
L	52	59	59	60	64	64	64	64

G. To introduce the tube into the fitting we recommend to use the appliance device shown in picture.

- Fix the special assembling device onto the pipe.
- Fix the fitting upon the device.
- With the lever, slide the fitting onto the pipe till you reach the reference mark.

G. Para introducir el tubo en el accesorio se aconseja utilizar un equipo como el mostrado en la imagen.

- Fije un dispositivo de ensamblaje especial sobre el tubo.
- Fije el accesorio sobre el dispositivo.
- Con la palanca, deslice el accesorio sobre el tubo hasta que se alcance la marca de referencia.

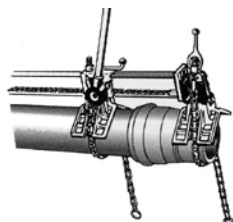

UP. 05. RJ - UNION SOCKET
Union socket

- Rubber ring joint
- Metric series

Manguito unión

- Con junta elástica
- Serie métrica

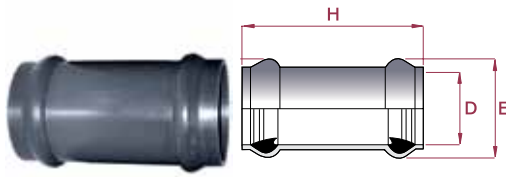

D	DN	PN	REF.	CODE
63	50	10	70 05 063 *	22917
75	65	10	70 05 075 *	22918
90	80	10	70 05 090 *	22919
110	100	10	70 05 110 *	22920
125	110	10	70 05 125 *	22921
140	125	10	70 05 140 *	22922
160	150	10	70 05 160 *	22923
200	175	10	70 05 200 *	22924
225	200	10	70 05 225 *	22925
250	225	10	70 05 250 *	22926
315	300	10	70 05 315 *	22927

E	H
86	380
102	380
120	380
144	380
161	380
178	380
202	380
248	400
277	500
304	500
382	500

* Distributed product
* Producto comercializado

VICTAULIC® COUPLING

ENLACE VICTAULIC®

Designed with a heavy housing for high pressure service. The housing key is wider than standard and the coupling housing is designed to clamp the bottom of the groove, thus providing an essentially rigid joint. It also eliminates movement at the joint.

Reduces linear or angular movement and is useful for valve connections and other points where rigidity is required.

Diseñado con una resistente cubierta para soportar altas presiones. La llave es más ancha que las estándares y el enlace está diseñado para agarrar el fondo de la ranura, proporcionando una unión rígida. También está pensado para eliminar los movimientos en la unión.

Reduce el movimiento lineal o angular y se puede usar para conexiones con válvulas o en otros sitios donde se requiera rigidez.

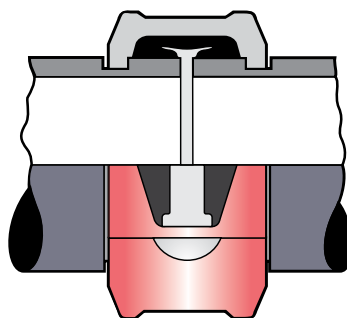

- Fast assembly.
- Allows misalignments up to 1°30'.
- EPDM joint.
- Coupling made of coated ductile iron.
- Bolts made of zinc plated carbon steel.

- Montaje rápido.
- Permite desalineaciones de hasta 1°30'.
- Junta en EPDM.
- Brida en hierro fundido pintado.
- Tornillos en acero zincado.

UP. 58. SFVT - VICTAULIC SOCKET

Victaulic® grooved flexible socket

- Female solvent socket
- Metric series

Enlace Victaulic®

- Encolar hembra
- Serie métrica

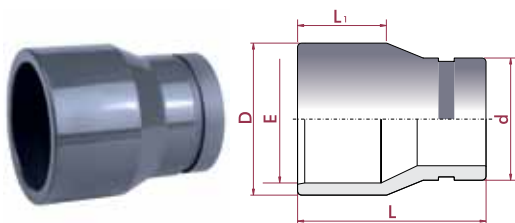

D - E x d	DN	PN	REF.	CODE
75 - 63 x 2"	2"	16	05 58 463	20162
110 - 90 x 3"	3"	16	05 58 490	20163
125 - 110 x 4"	4"	16	05 58 510	20164
180 - 160 x 6"	6"	10	05 58 560	21444

L	L ₁
93	44
132	63
151	71
183	90

UP. 58. VT - VICTAULIC COUPLING

Victaulic® grooved flexible coupling

Brida ranurada Victaulic®

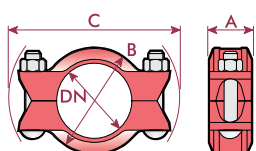

DN	REF.	CODE
2"	05 58 063*	20165
3"	05 58 090*	20166
4"	05 58 110*	20167
6"	05 58 160*	21445

A	B	C
51	89	168
51	121	197
54	152	245
64	219	321

* Distributed product
* Producto comercializado

PVC-U LOOSE FLANGES BRIDAS LOCAS PVC-U

• EN 1452 / ISO 15493 / ISO EN 558 / BS EN 1092-1 Flange System.
• We recommend to follow flange installation instructions carefully to avoid any unnecessary tensions.

• Sistema de bridas EN 1452 / ISO 15493 / ISO EN 558 / BS EN 1092-1.
• Recomendamos seguir exactamente las normas de montaje de bridas con objeto de evitar tensiones innecesarias.

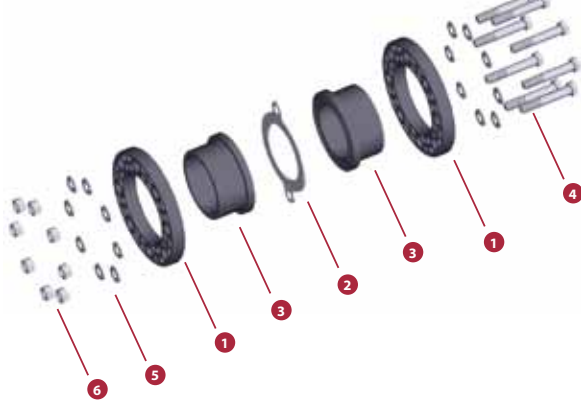
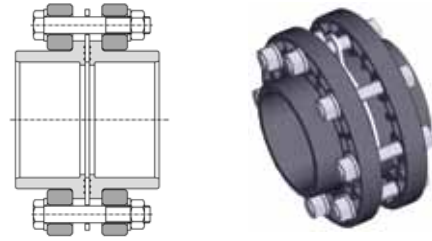

FIG.	Parts	Despiece	Material
1	Flange	Brida	PVC-U / PP
2	Flat gasket	Junta plana	EVA / EPDM
3	Flange adaptor **	Manguito portabridas **	PVC-U
4	Screw DIN 931	Tornillo DIN 931	5.6 Zinc plated steel / A2 Stainless steel *
5	Washer DIN 125-A	Arandela DIN 125-A	
6	Nut DIN 934	Tuerca DIN 934	

D	2		1		3
	EVA	EPDM	PVC-U	PP	PVC-U
20	✓	✓	✓		✓
25	✓	✓	✓		✓
32	✓	✓	✓		✓
40	✓	✓	✓		✓
50	✓	✓	✓	✓	✓
63	✓	✓	✓	✓	✓
75	✓	✓	✓	✓	✓
90	✓	✓	✓	✓	✓
110	✓	✓	✓	✓	✓
125	✓	✓	✓	✓	✓
140	✓	✓	✓	✓	✓
160	✓	✓	✓	✓	✓
200	✓	✓	✓	✓	✓
225	✓	✓	✓	✓	✓
250	✓	✓	✓	✓	✓
315	✓	✓	✓	✓	✓
400		✓	✓	✓	✓
500		✓	✓	✓	✓

* On order A4 Stainless steel
Bajo pedido acero inoxidable A4

** Flange adaptor available in BS and ASTM solvent socket standards
Manguito portabridas disponible en standards BS y ASTM

TIGHTENING SEQUENCE ORDEN DE APRIETE

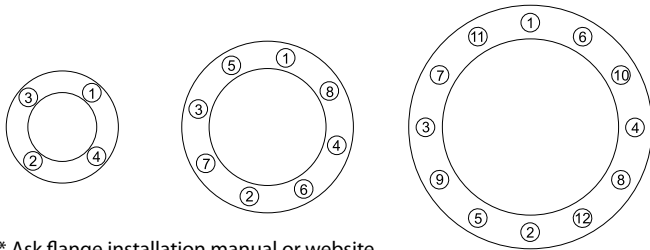

* Ask flange installation manual or website
Consultar manual instalación bridas o website

TIGHTENING MAXIMUM TORQUE MÁXIMO PAR DE APRIETE

D	DN	inch	N · m	Kgf · cm	inch · lbs
63-75	65	2 ½"	25	255	221
90	80	3"	25	255	221
110	100	4"	30	306	265
125-140	125	5"	35	257	310
160	150	6"	40	408	354
200-225	200	8"	50	510	442
250-280	250	10"	80	816	708
315	300	12"	80	816	708

UP. 52. RA - FLANGE KIT

Flange set (kit)

- Loose flange
- Female solvent socket
- Metric series

Enlace con bridas (kit)

- Brida loca
- Encolar hembra
- Serie métrica

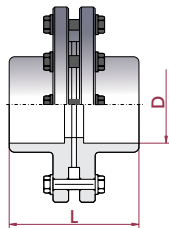

D	DN	PN	REF. (EVA)	CODE (EVA)	REF. (EPDM)	CODE (EPDM)	L
20	15	16	05 52 020 RA	66996	05 52 020 RA EPDM	67071	
25	20	16	05 52 025 RA	66997	05 52 025 RA EPDM	67072	
32	25	16	05 52 032 RA	66998	05 52 032 RA EPDM	67073	
40	32	16	05 52 040 RA	66999	05 52 040 RA EPDM	67074	
50	40	16	05 52 050 RA	67000	05 52 050 RA EPDM	67075	
63	50	16	05 52 063 RA	67037	05 52 063 RA EPDM	67076	
75	65	16	05 52 075 RA	67059	05 52 075 RA EPDM	67077	97
90	80	16	05 52 090 RA	67064	05 52 090 RA EPDM	67078	115
110	100	16	05 52 110 RA	67065	05 52 110 RA EPDM	67079	136
125	16	16	05 52 125 RA	67070	05 52 125 RA EPDM	67080	152
140	125	16	05 52 140 RA	67066	05 52 140 RA EPDM	67081	166
160	150	10	05 52 160 RA	67067	05 52 160 RA EPDM	67082	186
200	10	10	05 52 200 RA	67068	05 52 200 RA EPDM	67083	227
225	200	10	05 52 225 RA	67069	05 52 225 RA EPDM	67084	255
250	10	10	05 52 250 RA	66955	05 52 250 RA EPDM	66973	
315	300	10	05 52 315 RA	66956	05 52 315 RA EPDM	66974	
400	400	6	-	-	05 52 400 RA EPDM	66957	
500	500	4	-	-	05 52 500 RA EPDM	66958	

UP. 10. SF - FLANGE ADAPTOR

PVC-U flange adaptor (sub flange)

- Female solvent socket
- Metric series

Manguito portabridas PVC-U

- Encolar hembra
- Serie métrica

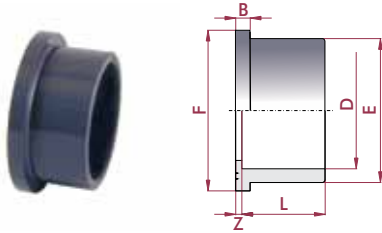

D	DN	PN	REF.	CODE
20	15	16	05 10 020 ³	07692
25	20	16	05 10 025 ³	07693
32	25	16	05 10 032 ³	07694
40	32	16	05 10 040 ³	07695
50	40	16	05 10 050 ³	02020
63	50	16	05 10 063 ³	02021
75	65	16	05 10 075 ³	02022
90	80	16	05 10 090 ³	02023
110	100	16	05 10 110 ³	02024
125	110	16	05 10 125 ³	02025
140	125	16	05 10 140 ³	02026
160	150	10	05 10 160 ³	02027
200	175	10	05 10 200	02028
225	200	10	05 10 225	02029
250	225	10	05 10 250	02030
315	300	10	05 10 315	02031
400	375	6	05 10 400*	05341
500	480	4	05 10 402*	05342

L	Z	B	E	F
16	3	6	27	34
19	3	7	33	41
22	3	7	41	50
26	3	8	50	61
31	3	8	61	73
38	3	9	76	90
44	3	10	90	106
51	5	11	108	125
61	5	12	131	150
69	5	13	148	168
76	5	14	165	188
86	5	16	188	213
106	6	20	225	247
119	6	25	248	274
131	8	27	282	328
164	8	30	342	378
206	12	30	432	483
153	8	24	532	574

UP. 11. FLG - FLANGE

PVC-U loose flange

Brida loca PVC-U

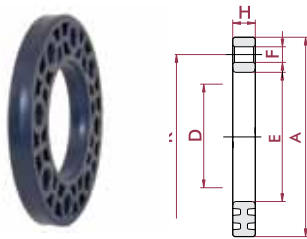

D	DN	PN	REF.	CODE
20	15	16	05 11 020	07696
25	20	16	05 11 025	07697
32	25	16	05 11 032	07698
40	32	16	05 11 040	07699
50	40	16	05 11 050	02032
63	50	16	05 11 063	02033
75	65	16	05 11 075	02034
90	80	16	05 11 090	02035
110	100	16	05 11 110	02036
125	125	16	05 11 125	02037
140	125	16	05 11 140	02038
125 ⁵		16	05 11 141 ³	02039
160	150	10	05 11 160	02040
200		10	05 11 200	02041
225	200	10	05 11 225	02042
200 ⁵		10	05 11 226 ³	09039
250		10	05 11 250	02043
315	300	10	05 11 315	02044
400	400	6	05 11 400*	05343
500	500	4	05 11 402*	05344

E	A	H	K	F
28	95	12	65	14 x 4
34	105	13	75	14 x 4
42	115	15	85	14 x 4
51	140	16	100	18 x 4
62	150	17	110	18 x 4
78	165	18	125	18 x 4
92	185	22	145	18 x 4
110	200	23	160	18 x 8
133	220	24	180	18 x 8
150	230	26	190	18 x 8
167	250	28	210	18 x 8
150	250	28	210	18 x 8
190	285	31	240	22 x 8
226	315	32	270	22 x 8
250	340	32	295	22 x 8
226	340	32	295	22 x 8
284	400	34	350	22 x 12
348	445	36	400	22 x 12
442	565	34	515	26 x 16
533	657	30	600	26 x 20

⁴ Hole distance corresponding to DN125 flange
⁵ Hole distance corresponding to DN200 flange

⁴ Brida con distancia entre agujeros correspondiente a la brida DN125
⁵ Brida con distancia entre agujeros correspondiente a la brida DN200

PP. 12. FLG - PP FLANGE

PP flange (backing ring)

Brida PP

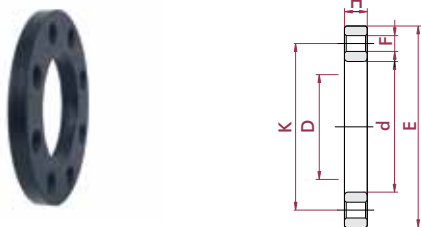

D	DN	PN	REF.	CODE
50	40	16	05 12 050	02045
63	50	16	05 12 063	02046
75	65	16	05 12 075	02047
90	80	16	05 12 090	02048
110	100	16	05 12 110	02049
125		16	05 12 125	02050
140	125	16	05 12 140	02051
125 ⁴		16	05 12 141 ³	02052
160	150	10	05 12 160	02053
200		10	05 12 200	02054
225	200	10	05 12 225	02055
200 ⁵		10	05 12 226 ³	02056

E	H	A	K	F
62	18	150	110	18 x 4
78	19	165	125	18 x 4
92	20	185	145	18 x 4
110	22	200	160	18 x 8
133	24	220	180	18 x 8
149	26	230	190	18 x 8
167	28	250	210	18 x 8
149	28	250	210	18 x 8
190	30	285	240	22 x 8
227	32	315	270	22 x 8
250	34	340	295	22 x 8
227	34	340	295	22 x 8

⁴ Hole distance corresponding to DN125 flange
⁵ Hole distance corresponding to DN200 flange

⁴ Brida con distancia entre agujeros correspondiente a la brida DN125
⁵ Brida con distancia entre agujeros correspondiente a la brida DN200

At the time to make the relationship between adaptor and flange, for the compatibility it prevails the D size of the corresponding pipe.
 Siempre que se deba relacionar manguito y brida, prevalece en su compatibilidad la medida D del tubo correspondiente.

* Distributed product
 * Producto comercializado

PVC-U FIX FLANGES BRIDAS FIJAS PVC-U

- EN 1452 / ISO 15493 Flange System.
- We recommend to follow flange installation instructions carefully to avoid any unnecessary tensions.

- Sistema de bridas EN 1452 / ISO 15493 .
- Recomendamos seguir exactamente las normas de montaje de bridas con objeto de evitar tensiones innecesarias.

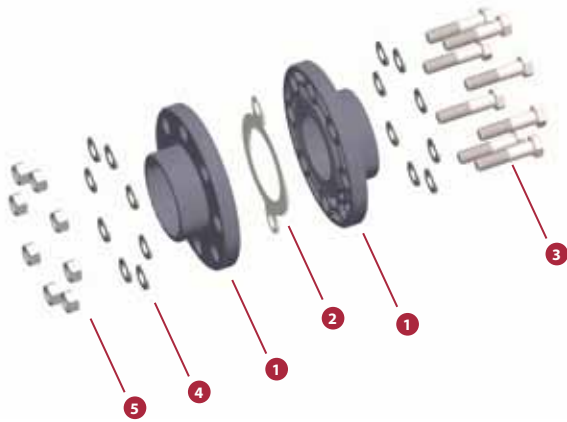
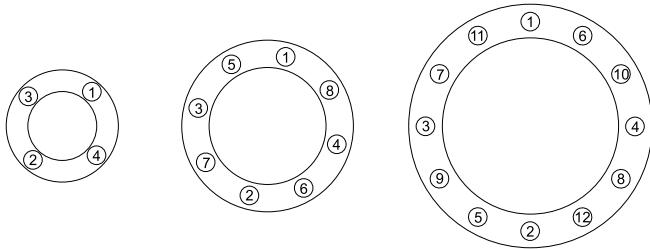

FIG.	Parts	Despiece	Material
1	Flange	Brida	PVC-U / PP
2	Flat gasket	Junta plana	EVA / EPDM
3	Screw DIN 931	Tornillo DIN 931	5,6 Zinc plated steel / A2 Stainless steel *
4	Washer DIN 125-A	Arandela DIN 125-A	
5	Nut DIN 934	Tuerca DIN 934	

* On order A4 Stainless steel
Bajo pedido acero inoxidable A4

TIGHTENING SEQUENCE ORDEN DE APRIETE



* Ask flange installation manual or website
Consultar manual instalación bridas o website

D	2		1
	EVA	EPDM	PVC-U
20	✓	✓	✓
25	✓	✓	✓
32	✓	✓	✓
40	✓	✓	✓
50	✓	✓	✓
63	✓	✓	✓
75	✓	✓	✓
90	✓	✓	✓
110	✓	✓	✓
125	✓	✓	✓
140	✓	✓	✓
160	✓	✓	✓
200	✓	✓	✓
225	✓	✓	✓

TIGHTENING MAXIMUM TORQUE MÁXIMO PAR DE APRIETE

D	DN	inch	N · m	Kgf · cm	inch · lbs
63-75	65	2 ½"	25	255	221
90	80	3"	25	255	221
110	100	4"	30	306	265
125-140	125	5"	35	257	310
160	150	6"	40	408	354
200-225	200	8"	50	510	442
250-280	250	10"	80	816	708
315	300	12"	80	816	708

UP. 52. SF - FLANGE KIT

Flange set (kit)

- Fix flange
- Female solvent socket
- Metric series

Enlace con bridas (kit)

- Brida fija
- Encolar hembra
- Serie métrica

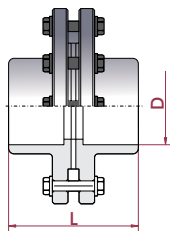

D	DN	PN	REF. (EVA)	CODE (EVA)	REF. (EPDM)	CODE (EPDM)	L
20	15	16	05 52 020	66949	05 52 020 EPDM	66959	
25	20	16	05 52 025	66950	05 52 025 EPDM	66960	
32	25	16	05 52 032	66951	05 52 032 EPDM	66961	
40	32	16	05 52 040	66952	05 52 040 EPDM	66962	
50	40	16	05 52 050	66953	05 52 050 EPDM	66963	
63	50	16	05 52 063	66954	05 52 063 EPDM	66964	
75	65	16	05 52 075	02371	05 52 075 EPDM	66965	97
90	80	16	05 52 090	02372	05 52 090 EPDM	66966	115
110	100	16	05 52 110	02373	05 52 110 EPDM	66967	136
125	110	16	05 52 125	02374	05 52 125 EPDM	66968	152
140	125	16	05 52 140	02375	05 52 140 EPDM	66969	166
160	150	10	05 52 160	02376	05 52 160 EPDM	66970	186
200	175	10	05 52 200	02377	05 52 200 EPDM	66971	227
225	200	10	05 52 225	02378	05 52 225 EPDM	66972	255

UP. 25. FLG - STUB AND BACKING RING

PVC-U fix flange (stub & backing ring)

- Female solvent socket
- Metric series

Brida fija PVC-U

- Encolar hembra
- Serie métrica

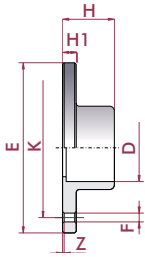

⁴ Hole distance corresponding to DN125 flange

⁴ Brida con distancia entre agujeros correspondiente a la brida DN125

D	DN	PN	REF.	CODE
20	15	16	05 25 020 *	22575
25	20	16	05 25 025 *	22576
32	25	16	05 25 032 *	22577
40	32	16	05 25 040 *	22578
50	40	16	05 25 050 *	22579
63	50	16	05 25 063 *	22580
75	65	16	05 25 075	02226
90	80	16	05 25 090	02227
110	100	16	05 25 110	02228
125		16	05 25 125	02229
125 ⁴		16	05 25 126 ³	02234
140	125	16	05 25 140	02230
160	150	10	05 25 160	02231
200		10	05 25 200	02232
225	200	10	05 25 225	02233

H	H1	Z	A	K	F
20	13	4	95	65	14 x 4
23	14	4	105	75	14 x 4
26	16	4	115	85	14 x 4
30	17	4	142	100	18 x 4
35	18	4	152	110	18 x 4
42	20	4	165	125	18 x 4
47	19	3	185	145	18 x 4
56	22	5	200	160	18 x 8
66	23	5	220	180	18 x 8
74	26	5	230	190	18 x 8
74	26	5	250	210	18 x 8
81	28	5	250	210	18 x 8
91	30	5	285	240	22 x 8
112	30	6	315	270	22 x 8
125	33	6	340	295	22 x 8

* Distributed product
* Producto comercializado

UP. 37. FLG - BLIND FLANGE

PVC-U blind flange

Brida ciega PVC-U

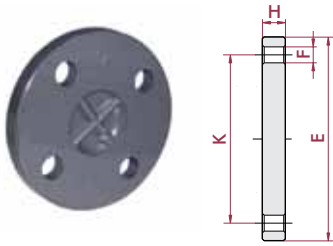

⁵ Hole distance corresponding to DN200 flange

⁵ Brida con distancia entre agujeros correspondiente a la brida DN200

D	DN	PN	REF.	CODE
20	15	16	05 37 020 *	22561
25	20	16	05 37 025 *	22562
32	25	16	05 37 032 *	22563
40	32	16	05 37 040 *	22564
50	40	16	05 37 050 *	22565
63	50	16	05 37 063 *	22566
75	65	16	05 37 075 *	22567
90	80	16	05 37 090 *	22568
110	100	16	05 37 110 *	22569
125		16	05 37 125 *	22570
140	125	16	05 37 140 *	22571
160	150	10	05 37 160 *	22572
200 ^a		10	05 37 200 ³ *	22573
225	200	10	05 37 225 *	22574

H	A	K	F
11	95	65	14 x 4
12	105	75	14 x 4
14	115	85	14 x 4
15	142	100	18 x 4
16	152	110	18 x 4
18	165	125	18 x 4
19	185	145	18 x 4
20	200	160	18 x 8
22	220	180	18 x 8
24	230	190	18 x 8
26	250	210	18 x 8
28	285	240	22 x 8
30	340	295	22 x 8
30	340	295	22 x 8

EVA. 14 - FLAT GASKET

EVA flat gasket
• Metric series

Junta plana EVA
• Serie métrica

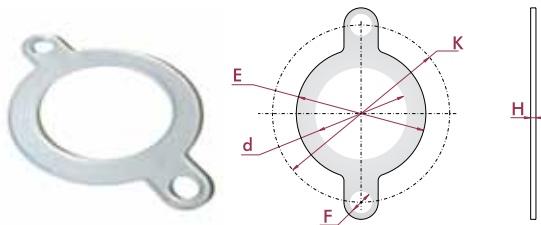

D	DN	REF.	CODE
20	15	05 14 020 *	07700
25	20	05 14 025 *	07701
32	25	05 14 032 *	07702
40	32	05 14 040 *	07703
50	40	05 14 050 *	02061
63	50	05 14 063 *	02062
75	65	05 14 075 *	02063
90	80	05 14 090 *	02064
110	100	05 14 110 *	02065
125		05 14 125 *	02066
140	125	05 14 140 *	02067
160	150	05 14 160 *	02068
200		05 14 200 *	02069
225	200	05 14 225 *	02070
250		05 14 250 *	02071
315	300	05 14 315 *	02072

d	E	H	K	F
20	32	2	65	14
25	39	2	75	14
32	48	2	85	14
40	59	2	100	18
50	71	3	110	18
63	88	3	125	18
75	104	3	145	18
90	123	3	160	18
110	148	4	180	18
125	166	4	190	18
140	186	4	210	18
160	211	4	240	22
200	245	5	270	22
225	275	5	295	22
250	328	3	350	22
315	378	3	400	22

PDM. 14 - FLAT GASKET

EPDM flat gasket
• Metric series

Junta plana EPDM
• Serie métrica

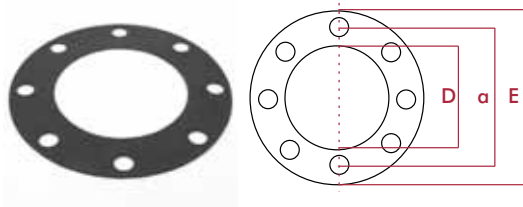

D	DN	REF.	CODE
20	15	05 14 020 EPDM *	66933
25	20	05 14 025 EPDM *	66934
32	25	05 14 032 EPDM *	66935
40	32	05 14 040 EPDM *	66936
50	40	05 14 050 EPDM *	66937
63	50	05 14 063 EPDM *	66938
75	65	05 14 075 EPDM *	66939
90	80	05 14 090 EPDM *	66340
110	100	05 14 110 EPDM *	66941
125		05 14 125 EPDM *	66942
140	125	05 14 140 EPDM *	66943
160	150	05 14 160 EPDM *	66944
200		05 14 200 EPDM *	66945
225	200	05 14 225 EPDM *	66946
250		05 14 250 EPDM *	66947
315	300	05 14 315 EPDM *	66948
400	353	05 14 400 EPDM *	05345
500	475	05 14 402 EPDM *	05346

H	E	a	F
2,5	93	34	16 x 4
2,5	103	41	19 x 4
2,5	115	50	22 x 4
2,5	140	100	20 x 4
2,5	150	110	20 x 4
2,5	165	125	20 x 4
2,5	185	145	20 x 4
2,5	200	160	20 x 8
2,5	220	180	20 x 8
2,5	245	210	20 x 8
2,5	250	210	20 x 8
2,5	285	240	22 x 8
2,5	335	295	22 x 8
2,5	340	295	22 x 8
2,5	395	350	22 x 12
2,5	440	400	22 x 12
2,5	565	515	22 x 16
2,5	660	620	25 x 20

* Distributed product
* Producto comercializado

BOLTS TORNILLERÍA

Required bolt size depending on each application of the flange:
butterfly valve, coupling or swing check valve.

Modelo y tamaño necesario de tornillería para cada una de las aplicaciones
de la brida: válvula de mariposa, enlace o válvula de clapeta.



Flange set (loose flange)
Enlace bridas (brida loca)

Industrial ball valve with loose flanges
Válvula de bola Industrial con bridas locas

FLANGE SIZE	SCREW SIZE	UNITS	CODE	CODE
			5.6 zinc plated steel	A2 stainless steel
D20, D25	M12 x 60	4	16061	60515
D32	M12 x 60	4	16061	60515
D40	M16 x 70	4	16061	60515
D50	M16 x 70	4	02437	60516
D63	M16 x 70	4	02437	60516
D75	M16 x 80	4	02438	60517
D90	M16 x 90	8	02439	60518
D110	M16 x 90	8	02439	60518
D125	M16 x 100	8	66775	66783
D140	M16 x 100	8	66775	66783
D160	M16 x 110	8	66776	66784
D200	M20 x 120	8	66777	66785
D225	M20 x 130	8	66778	66786
D250	M20 x 140	12	66779	66787
D280	M20 x 150	12	66780	66788
D315	M20 x 160	12	02448	60535
D400	M24 x 160	12	66782	66790
D500	M24 x 140	12	66781	66789



Flange set (fix flange)
Enlace bridas (brida fija)

FLANGE SIZE	SCREW SIZE	UNITS	CODE	CODE
			5.6 zinc plated steel	A2 stainless steel
D20, D25	M 12 x 60	4	16061	60515
D32	M 12 x 60	4	16061	60515
D40	M 16 x 70	4	02437	60516
D50	M 16 x 70	4	02437	60516
D63	M 16 x 70	4	02437	60516
D75	M 16 x 70	4	02437	60516
D90	M 16 x 70	8	02437	60516
D110	M 16 x 80	8	02438	60517
D125	M 16 x 80	8	02438	60517
D140	M 16 x 90	8	02439	60518
D160	M 20 x 90	8	02446	60533
D200	M 20 x 110	8	02447	60534
D225	M 20 x 110	8	02447	60534



Butterfly valve (loose flange)
Válvula mariposa (brida loca)

FLANGE SIZE	SCREW SIZE	UNITS	CODE	CODE
			5.6 zinc plated steel	A2 stainless steel
D63	M 16 x 120	4	02440	60519
D75	M 16 x 140	4	02442	60526
D90	M 16 x 150	8	02443	60527
D110	M 16 x 160	8	02444	60528
D125	M 16 x 170	8	02445	60529
D140	M 16 x 170	8	02445	60529
D160	M 20 x 200	8	20263	60538
D200	M 20 x 210	8	02451	60539
D225	M 20 x 230	8	02452	60547
D250	M 20 x 270	12	07721	60548
D280	M 20 x 270	12	07721	60548
D315	M 20 x 310	12	07722	60549



Butterfly valve (fix flange)
Válvula mariposa (brida fija)

FLANGE SIZE	SCREW SIZE	UNITS	CODE	CODE
			5.6 zinc plated steel	A2 stainless steel
D63	M 16 x 120	4	02440	60519
D75	M 16 x 120	4	02440	60519
D90	M 16 x 130	8	02441	60525
D110	M 16 x 130	8	02441	60625
D125	M 16 x 140	8	02442	60526
D140	M 16 x 150	8	02443	60527
D160	M 20 x 160	8	02448	60535
D200	M 20 x 180	8	02449	60536
D225	M 20 x 190	8	02450	60537



Swing check valve (loose flange)
Válvula de clapeta (brida loca)

FLANGE SIZE	SCREW SIZE	UNITS	CODE	CODE
			5.6 zinc plated steel	A2 stainless steel
D75	M 16 x 120	4	02440	60519
D90	M 16 x 120	8	02440	60519
D110	M 16 x 120	8	02440	60519
D125	M 16 x 130	8	02441	60525
D140	M 16 x 130	8	02441	60525
D160	M 20 x 160	8	02448	60535
D200	M 20 x 160	8	02448	60535
D225	M 20 x 180	8	02449	60536
D250	M 20 x 210	12	02451	60539
D315	M 20 x 230	12	02452	60547

* Valid for Industrial, Standard and Classic Series

* Válido para Serie Industrial, Standard y Classic

PVC-U UNIONS ENLACES 3 PIEZAS PVC-U

Unions are the preferred choice over flange adaptors for the connection of plastic pipes. With no metal parts, there is no corrosion and the weight is also reduced.

They are only available in small sizes (up until D110).

The union ends are manufactured in plain ends for solvent socket or thread always according the sizing standards, doing this system appropriate to adapt to other elements or systems. Cepex unions feature an o-ring in order to ensure better unions, so it is not needed the use of PTFE tape between nut and union end (it is only needed in the threaded ends).

They are not recommended when connected to pipe under bending stress.

The union nut should be tightened by hand. Must use a strap wrench for big sizes (D75, D90, D110).

With this type of unions, it is possible to mix several plastic materials.

Cuando hay que unir plásticos, éstos son preferidos a las bridas, ya que no contienen ninguna parte de metal y el diámetro exterior es más reducido.

En contrapartida sólo están disponibles para diámetros pequeños (hasta D110).

Los manguitos de conexión están fabricados en terminaciones lisas de encolado o roscadas, siempre bajo normativas standards, haciendo posible la adaptación a otros componentes (incluso de materiales distintos).

Los enlaces 3 piezas Cepex incorporan junta para asegurar estanqueidad entre los dos manguitos de la unión, por lo que no debe usarse cinta de PTFE entre tuerca y manguito (usar cinta de PTFE solamente en las terminaciones de manguito roscadas). No son recomendables cuando el tubo tenga que estar sometido a fuerza de flexión (debido a posibles desalineaciones).

No es necesario el uso de ninguna herramienta, se rosca con las manos. Usar llave de cinta en diámetros grandes (D75, D90, D110).

Mediante estos enlaces, se pueden combinar diferentes tipos de plásticos.



CONNECTION POSSIBILITIES POSIBILIDADES DE CONEXIÓN

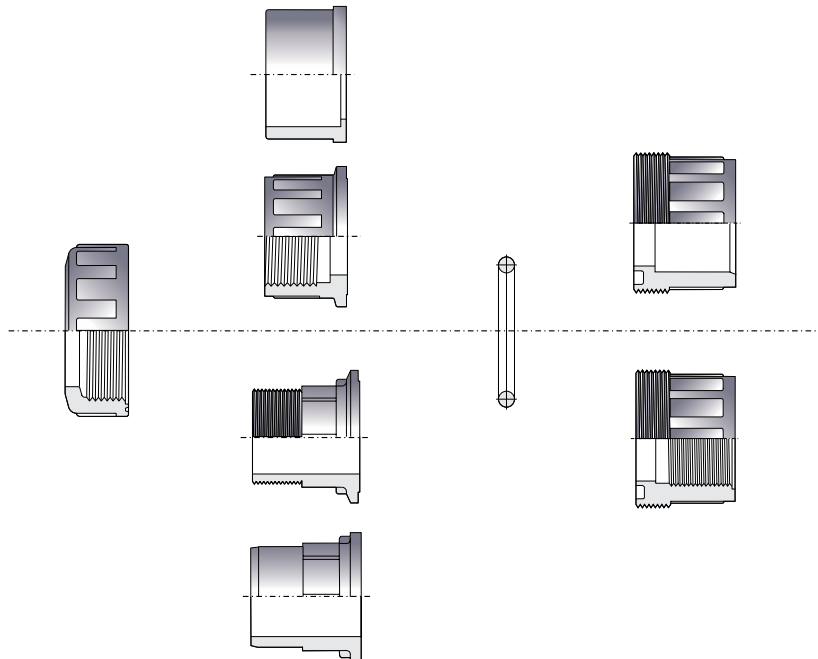

Available standards

Solvent socket: metric, BS, ASTM
Threaded: BSP, NPT

Standards disponibles

Encolar: métrico, BS, ASTM
Roscar: BSP, NPT

Ask for other types of unions or other materials (PP, PE100...)
Consultar otros tipos de conexión o materiales (PP, PE100...)

UP. 50. SF - UNION

Union

- Female solvent socket
- Metric series
- EPDM o-ring

Enlace 3 piezas

- Encolar hembra
- Serie métrica
- Anillo tórico en EPDM

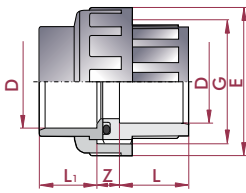

D	DN	PN	REF.	CODE
16	12	16	05 50 016	20157
20	15	16	05 50 020	02327
25	20	16	05 50 025	02328
32	25	16	05 50 032	02329
40	32	16	05 50 040	02330
50	40	16	05 50 050	02331
63	50	16	05 50 063	02332
75	65	10	05 50 075	02333
90	80	10	05 50 090	02334
110	100	10	05 50 110	02335

L	L ₁	Z	G	E	o-ring
14	14	13	¾"	34	15,5 x 2,6
16	16	13	1"	41	20,2 x 3,5
19	19	13	1¼"	52	28,2 x 3,5
22	22	13	1½"	60	32,9 x 3,5
26	26	15	2"	74	40,6 x 5,3
31	31	17	2¼"	80	47,0 x 5,3
38	38	21	2¾"	99	59,7 x 5,3
44	44	21	3½"	120	75,6 x 5,3
51	51	24	4"	138	91,4 x 5,3
61	61	26	5½"	179	110,5x5,3

UP. 50. SFT - UNION ADAPTOR

Union adaptor

- Female solvent socket x BSP female thread
- Metric series
- EPDM o-ring

Enlace 3 piezas mixto

- Encolar hembra x rosca hembra BSP
- Serie métrica
- Anillo tórico en EPDM

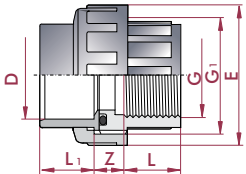

D x G	DN	PN	REF.	CODE
16 x ¾"	12	10	05 50 416	20158
20 x ½"	15	10	05 50 420	02336
25 x ¾"	20	10	05 50 425	02337
32 x 1"	25	10	05 50 432	02338
40 x 1¼"	32	10	05 50 440	02339
50 x 1½"	40	10	05 50 450	02340
63 x 2"	50	10	05 50 463	02341
75 x 2½"	65	10	05 50 475	02342
90 x 3"	80	10	05 50 490	02343
110 x 4"	100	10	05 50 510	02344

L	L ₁	Z	G ₁	E	o-ring
14	14	13	¾"	34	15,5 x 2,6
16	16	13	1"	41	20,2 x 3,5
19	19	13	1¼"	52	28,2 x 3,5
22	22	13	1½"	60	32,9 x 3,5
26	26	15	2"	74	40,6 x 5,3
31	31	17	2¼"	80	47,0 x 5,3
38	38	21	2¾"	99	59,7 x 5,3
44	44	21	3½"	120	75,6 x 5,3
51	51	24	4"	138	91,4 x 5,3
61	61	26	5½"	179	110,5x5,3

UP. 50. FT - UNION

Union

- BSP female thread
- EPDM o-ring

Enlace 3 piezas

- Rosca hembra BSP
- Anillo tórico en EPDM

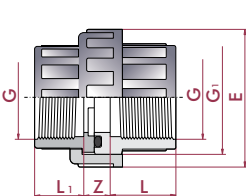

G	DN	PN	REF.	CODE
¾"	12	10	05 50 616	20159
½"	15	10	05 50 620	02345
¾"	20	10	05 50 625	02346
1"	25	10	05 50 632	02347
1¼"	32	10	05 50 640	02348
1½"	40	10	05 50 650	02349
2"	50	10	05 50 663	02350
2½"	65	10	05 50 675	07713
3"	80	10	05 50 690	07714
4"	100	10	05 50 710	07715

L	L ₁	Z	G ₁	E	o-ring
14	12	13	¾"	34	15,5 x 2,6
16	15	12	1"	41	20,2 x 3,5
19	17	12	1¼"	52	28,2 x 3,5
22	20	14	1½"	60	32,9 x 3,5
26	24	16	2"	74	40,6 x 5,3
31	25	18	2¼"	80	47,0 x 5,3
38	29	20	2¾"	99	59,7 x 5,3
44	34	21	3½"	120	75,6 x 5,3
51	37	24	4"	138	91,4 x 5,3
61	42	26	5½"	179	110,5x5,3

UP. 51. SMF - UNION

Union

- Male x female solvent socket
- Metric series
- EPDM o-ring

Enlace 3 piezas

- Encolar macho x hembra
- Serie métrica
- Anillo tórico en EPDM

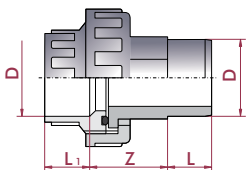

D	DN	PN	REF.	CODE
50	40	10	05 51 050	02351
63	50	10	05 51 063	02352

L	L ₁	Z
31	31	48
38	38	62

FPM o-rings available upon request.
Juntas en FPM disponibles bajo pedido.

UP. 51. SMT - UNION ADAPTOR

Union adaptor

- Female solvent socket x BSP male thread
- Metric series
- EPDM o-ring

Enlace 3 piezas mixto

- Encolar hembra x rosar macho BSP
- Serie métrica
- Anillo tórico en EPDM

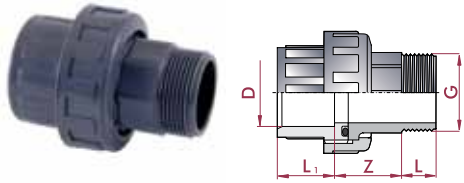

D x G	DN	PN	REF.	CODE
16 x 3/8"	12	10	05 51 416	20160
20 x 1/2"	15	10	05 51 420	02353
25 x 3/4"	20	10	05 51 425	02354
32 x 1"	25	10	05 51 432	02355
40 x 1 1/4"	32	10	05 51 440	02356
50 x 1 1/2"	40	10	05 51 450	02357
63 x 2"	50	10	05 51 463	02358
75 x 2 1/2"	65	10	05 51 475	02359
90 x 3"	80	10	05 51 490	02360
110 x 4"	100	10	05 51 510	02361

L ₁	L	Z
14	12	29
16	15	33
19	16	35
22	19	40
26	21	40
31	21	48
38	28	62
44	30	70
51	33	62
61	40	70

UP. 51. MFT - UNION

Union

- BSP female x male thread
- EPDM o-ring

Enlace 3 piezas

- Roscar hembra x macho BSP
- Anillo tórico en EPDM

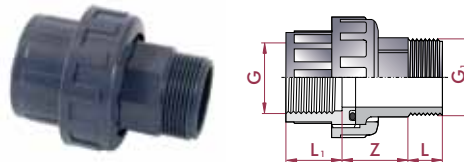

G x G ₁	DN	PN	REF.	CODE
3/8" x 3/8"	12	10	05 51 616	20161
1/2" x 1/2"	15	10	05 51 620	02362
3/4" x 3/4"	20	10	05 51 625	02363
1" x 1"	25	10	05 51 632	02364
1 1/4" x 1 1/4"	32	10	05 51 640	02365
1 1/2" x 1 1/2"	40	10	05 51 650	02366
2" x 2"	50	10	05 51 663	02367
2 1/2" x 2 1/2"	65	10	05 51 675	02368
3" x 3"	80	10	05 51 690	02369
4" x 4"	100	10	05 51 710	02370

L ₁	L	Z
14	12	30
16	15	33
19	16	35
22	19	40
26	21	40
31	21	48
38	28	62
44	30	70
51	33	62
61	40	70

UP. 51. SMT2 - UNION ADAPTOR

Union adaptor

- Female solvent socket x BSP male thread
- Metric series
- EPDM o-ring

Enlace 3 piezas mixto

- Encolar hembra x rosar macho BSP
- Serie métrica
- Anillo tórico en EPDM

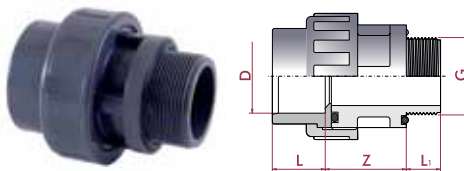

D x G	DN	PN	REF.	CODE
50 x 1 1/2"	40	10	05 51 250	07716
50 x 2"	40	10	05 51 251	26638
63 x 2"	50	10	05 51 263	07717

L	L ₁	Z
31	21	49
31	28	46
38	28	51

UP. 51. SFMT - UNION

Union adaptor

- Female solvent socket x BSP male thread
- Metric series
- EPDM o-ring

Enlace 3 piezas mixto

- Encolar hembra x rosar macho BSP
- Serie métrica
- Anillo tórico en EPDM

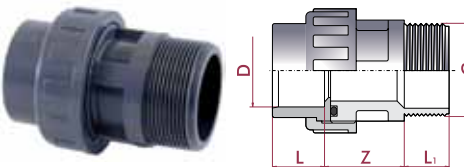

D x G	DN	PN	REF.	CODE
50 x 2"	40	10	05 51 451	09033

L	L ₁	Z
31	28	49

UP. 57. SFMT - SELF-ALIGN UNION

Self-align union

- Max. misalignment ±4°
- Female solvent socket x BSP male thread
- Metric series

Manguito orientable

- Desalineación max. ±4°
- Encolar hembra x rosar macho BSP
- Serie métrica

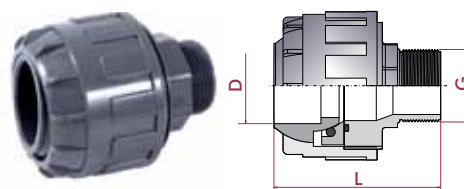

D x G	DN	PN	REF.	CODE
50 x 1 1/2"	40	10	05 57 550	18874

L
110

FITTINGS FOR UNIONS ACCESORIOS ENLACES 3 PIEZAS

UP. 21. SFMT - ADAPTOR BUSH UNION

Adaptor union bush

- Female solvent socket x BSP male thread
- Metric series

Manguito enlace mixto

- Encolar hembra x roscar macho BSP
- Serie métrica

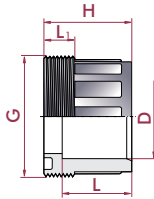

D x G	DN	PN	REF.	CODE
20 x 1"	15	10	05 21 420	02148
25 x 1¼"	20	10	05 21 425	02150
32 x 1½"	25	10	05 21 432	02151
40 x 2"	32	10	05 21 440	02153
50 x 2½"	40	10	05 21 450	02154
63 x 2¾"	50	10	05 21 463	02156
75 x 3½"	65	10	05 21 475	02157
90 x 4"	80	10	05 21 490	02158
110 x 5½"	100	10	05 21 510	02159

L	L ₁	H
16	10	26
19	11	29
22	12	32
28	15	39
31	16	46
38	18	56
44	18	62
51	18	69
61	31	79

UP. 21. MFT - UNION BUSH

Union bush

- BSP male x female thread

Manguito enlace

- Roscar macho x hembra BSP

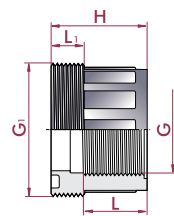

G ₁ x G	DN	PN	REF.	CODE
1" x ½"	15	10	05 21 620	02160
1¼" x ¾"	20	10	05 21 625	02162
1½" x 1"	25	10	05 21 632	02163
2" x 1¼"	32	10	05 21 640	02165
2½" x 1½"	40	10	05 21 650	02166
2¾" x 2"	50	10	05 21 663	02168
3½" x 2½"	65	10	05 21 675	02169
4" x 3"	80	10	05 21 690	02170
5½" x 4"	100	10	05 21 710	02171

L	L ₁	H
16	10	26
19	11	29
22	12	32
30	15	39
31	16	46
38	18	56
44	18	62
51	18	69
61	31	79

UP. 22. SF - UNION END

Union end

- Female solvent socket
- Metric series

Manguito enlace

- Encolar hembra
- Serie métrica

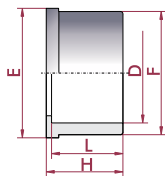

D	DN	PN	REF.	CODE
16	10	16	05 22 016	20229
20	15	16	05 22 020	02172
25	20	16	05 22 025	02173
32	25	16	05 22 032	02174
40	32	16	05 22 040	02175
50	40	16	05 22 050	02176
63	50	16	05 22 063	02177
75	65	16	05 22 075	02178
90	80	16	05 22 090	02179
110	100	16	05 22 110	02180

L	E	H	F
14	24	17	22
16	30	19	27
19	39	22	36
22	45	25	41
26	56	29	53
31	63	34	59
38	78	41	74
44	97	47	92
51	110	56	105
61	147	66	131

UP. 22. FT - UNION END

Union end

- BSP female thread
- Metric series

Manguito enlace

- Roscar hembra
- Serie métrica

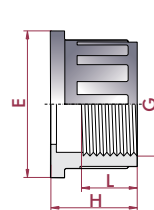

G	DN	PN	REF.	CODE
¾"	10	10	05 22 616	20230
½"	15	10	05 22 620	16310
¾"	20	10	05 22 625	16311
1"	25	10	05 22 632	16312
1¼"	32	10	05 22 640	16313
1½"	40	10	05 22 650	16314
2"	50	10	05 22 663	16315
2½"	65	10	05 22 675	16316
3"	80	10	05 22 690	16317
4"	100	10	05 22 710	16318

L	H	E
12	17	24
15	21	30
17	23	39
20	26	45
24	30	56
25	35	63
29	42	78
34	48	97
37	57	110
42	69	146

UP. 22. MT - UNION END
Union end

- BSP male thread

Manguito

- Roscar macho BSP

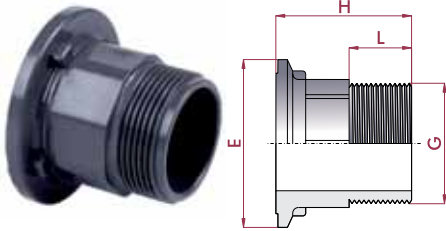

G	PN	REF.	CODE
3/8"	10	05 22 416	25959
1/2"	10	05 22 420	25960
3/4"	10	05 22 425	25961
1"	10	05 22 432	25962
1 1/4"	10	05 22 440	25963
1 1/2"	10	05 22 450	25964
2"	10	05 22 463	25965
2 1/2"	10	05 22 475	25966
3"	10	05 22 490	25967
4"	10	05 22 510	25968

L	H	E
12	33	24
15	38	30
16	41	39
19	48	45
21	50	57
21	57	63
28	70	78
30	72	97
33	77	110
40	98	147

UP. 22. SM - UNION END
Union end

- Male solvent socket
- Metric series

Manguito

- Encolar macho
- Serie métrica

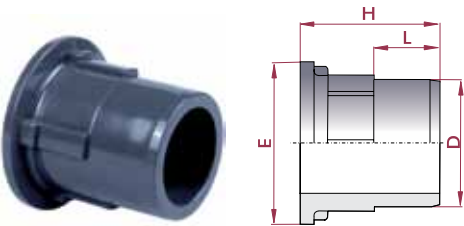

D	PN	REF.	CODE
50	16	05 22 250	25957
63	16	05 22 263	25958

L	H	E
31	66	63
38	80	78

UP. 23. FT - UNION NUT
Union nut

- BSP female thread

Tuerca

- Roscar hembra BSP



G	PN	REF.	CODE
3/4" (3/4")	10	05 23 625	02187
1" (1/2")	10	05 23 632	02188
1 1/4" (3/4")	10	05 23 640	02189
41,5	10	05 23 641	02190
1 1/2" (1")	10	05 23 650	02191
2" (1 1/4")	10	05 23 663	02192
2 1/4" (1 1/2")	10	05 23 664	02193
2"	10	05 23 665	02194
2 1/2"	10	05 23 675	02195
2 3/4" (2")	10	05 23 676	02196
3 1/2" (2 1/2")	10	05 23 692	02197
4" (3")	10	05 23 710	02198
5 1/2" (4")	10	05 23 741	02199

L	H	E	D	Di
15	20	36	22	24
15	20	41	27	30
16	22	52	36	39
12	18	53	33	39
20	26	60	41	45
21	26	74	53	57
22	30	80	59	63
19	28	70	46	54
18	27	90	64	72
28	36	99	74	78
28	36	120	92	97
28	38	133	105	110
41	56	177	131	148

The size of the corresponding union is indicated in brackets.

Entre paréntesis se indica la medida del enlace 3 piezas correspondiente.

PVC-U SPIGOTS ENLACES ESPIGA PVC-U

UP. 55. SPI - SPIGOT UNION

Spigot and nut union

Conjunto espiga y tuerca

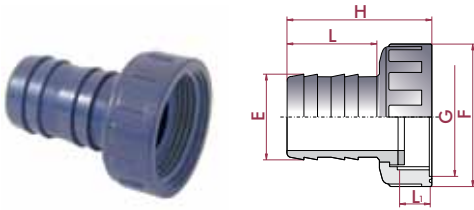

E x G	REF.	CODE
16 x 3/4"	05 55 016	02399
18 x 3/4"	05 55 018	02400
20 x 3/4"	05 55 020	02401
25 x 1"	05 55 025	02402
20 x 1"	05 55 026	15764
30 x 1 1/4"	05 55 032	02403
40 x 1 1/2"	05 55 040	02404
50 x 2"	05 55 050	02405
38 x 2"	05 55 051	02406
60 x 2 1/2"	05 55 063	02407

H	F	L	L ₁
46	36	35	10
46	36	35	10
49	36	38	10
56	41	42	10
51	41	36	10
66	52	47	10
73	60	52	14
82	74	57	14
82	74	57	14
88	90	60	18

UP. 55. SPIFT - SPIGOT UNION

Spigot union female threaded

Enlace espiga rosca hembra

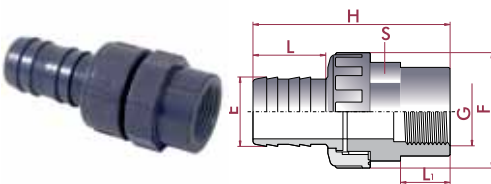

E x G	REF.	CODE
16 x 3/4"	05 55 416	02408
18 x 1/2"	05 55 418	02409
20 x 1/2"	05 55 420	02410
25 x 3/4"	05 55 425	02411
30 x 1"	05 55 432	02412
40 x 1 1/4"	05 55 440	02413
50 x 1 1/2"	05 55 450	02414
38 x 1 1/2"	05 55 451	02415
60 x 2"	05 55 463	02416

H	F	S	L	L ₁
66	36	32	35	14
70	36	32	35	18
73	36	32	38	18
81	41	36	42	19
98	52	46	47	25
106	61	55	52	25
116	74	65	57	25
116	74	65	57	25
127	90	80	60	29

UP. 55. SPIMT - SPIGOT UNION

Spigot union male threaded

Enlace espiga rosca macho

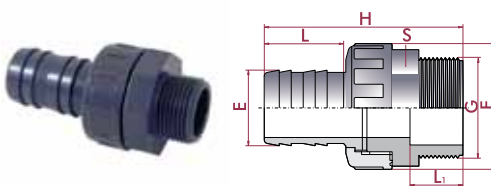

E x G	REF.	CODE
16 x 3/4"	05 55 616	02417
18 x 1/2"	05 55 618	02418
20 x 1/2"	05 55 620	02419
25 x 3/4"	05 55 625	02420
30 x 1"	05 55 632	02421
40 x 1 1/4"	05 55 640	02422
50 x 1 1/2"	05 55 650	02423
38 x 1 1/2"	05 55 651	02424
60 x 2"	05 55 663	02425

H	F	S	L	L ₁
66	36	32	35	14
70	36	32	35	18
73	36	32	38	18
81	41	36	42	19
98	52	46	47	25
106	61	55	52	25
116	74	65	57	25
116	74	65	57	25
127	90	80	60	29

UP. 56. SF - FITTING CONNECTION

Fitting connection
• Female solvent socket
• Metric series

Conjunto raccord conexión
• Encolar hembra
• Serie métrica

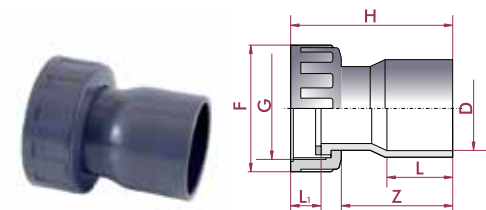

D x G	PN	REF.	CODE
40 x 2"	16	05 56 440	05350
50 x 2"	16	05 56 450	05351

L	Z	H	F	L ₁
26	16	46	75	17
39	66	96	75	18

PVC-U MANIFOLD FITTINGS

COLECTORES PVC-U

- Manifold fittings specially designed for the fast connection of 1" threaded elements, like electric valves assemblies, water supply, etc.
- Allowing fast and trouble-free installations.
- Available sizes: 1"
- Material: PVC-U
- PN 10 (150 psi)

Most irrigation systems need multiple watering stations, either for small residential areas, large landscapes or agriculture areas. At home one might have separate stations for the lawn and flower beds or there may not be enough water to irrigate the whole garden at the same time. This is when a series of valves is required.

These valves need to be connected together to the same source of water. The older ways were to create a manifold with costly galvanised metal or permanent assemblies.

Now with Cepex manifold fittings the job can be done:

- easier: no tools are required
- quicker: all parts are made to fit into each other
- more flexible: easy to change once assembled

- Accesorios colectores especialmente diseñados para la conexión rápida de elementos roscados de 1", tales como instalaciones con electroválvulas, suministro de agua, etc.
- Permiten realizar instalaciones con total facilidad y rapidez.
- Medidas disponibles: 1"
- Material: PVC-U
- PN 10 (150 psi)

La mayoría de sistemas de riego, ya sean pequeños para riego residencial o de mayores dimensiones para riego de zonas verdes o agrícola, requieren del uso de múltiples estaciones de riego.

En casa, es probable disponer de estaciones separadas para el césped y para las plantas, o puede no estar disponible la suficiente agua para regar todo el jardín a la vez. Es en estos casos que se requiere de series de válvulas.

Estas válvulas necesitan ser conectadas al mismo punto de suministro de agua. Antiguamente se instalaban colectores de metal galvanizado de alto coste o con montajes permanentes.

Ahora con los accesorios para colectores Cepex, este trabajo puede hacerse de una forma más:

- fácil: no se requieren herramientas
- rápida: todos los componentes están fabricados para encajar entre ellos
- flexible: es fácil hacer cambios una vez montados

UP. 01. MFD. FF - MANIFOLD ELBOW

- 90° elbow**
• Female/female

- Codo 90°**
• Hembra/hembra

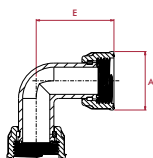

G	PN	REF.	CODE
1"	10	72 01 632	41850

A	E
43	57

UP. 01. MFD. FM - MANIFOLD ELBOW

- 90° elbow**
• Female/male

- Codo 90°**
• Hembra/macho

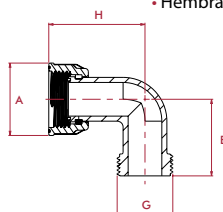

G	PN	REF.	CODE
1"	10	72 01 432	41851

A	E	H
43	46	57

UP. 03. MFD. FFM - MANIFOLD TEE

- 90° tee**
• Female/female/male

- Té 90°**
• Hembra/hembra/macho

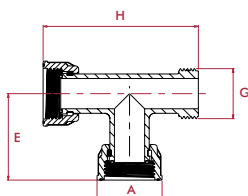

G	PN	REF.	CODE
1"	10	72 03 432	41852

A	E	H
43	57	102

UP. 28. MFD. FFFM - MANIFOLD CROSS

Cross

• Female/female/female/male

Cruz

• Hembra/hembra/hembra/macho

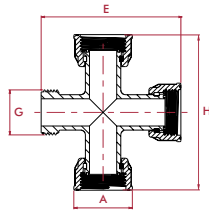

G	PN	REF.	CODE
1"	10	72 28 432	41852

A	E	H
43	103	114

UP. 05. MFD. FF - MANIFOLD SOCKET

Socket

• Female/female

Manguito

• Hembra/hembra

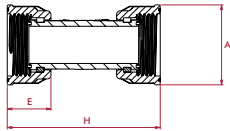

G	PN	REF.	CODE
1"	10	72 05 632	41854

A	E	H
43	24	82

UP. 05. MFD. FM - MANIFOLD SOCKET

Socket

• Female/male

Manguito

• Hembra/macho

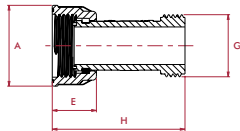

G	PN	REF.	CODE
1"	10	72 05 432	41855

A	E	H
43	24	71

UP. 18. MFD. MT - MANIFOLD NIPPLE

Nipple

• Male threaded

Machón doble rosca

• Roscar macho



G	PN	REF.	CODE
1"	10	72 18 032	41856

UP. 33. MFD. MTR - MANIFOLD REDUCING NIPPLE

Reducing nipple

• Male threaded

Machón reducido

• Roscar macho



G	PN	REF.	CODE
1"	10	72 33 432	41852

UP. 07. MFD. FT - MANIFOLD CAP

Cap

• Female thread

Tapón

• Roscar hembra

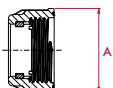

G	PN	REF.	CODE
1"	10	72 07 032	41861

A
43

UP. 26. MFD. 2OUT - MANIFOLD
2-outlet manifold

- 3 Female thread x 1 male thread

Colector PVC-U 2 salidas

- 3 Rosca hembra x 1 rosca macho

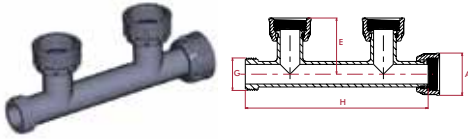

G	PN	REF.	CODE
1"	10	72 26 232	41858

A	E	H
43	57	186

UP. 26. MFD. 3OUT - MANIFOLD
3-outlet manifold

- 4 Female thread x 1 male thread

Colector PVC-U 3 salidas

- 4 Rosca hembra x 1 rosca macho

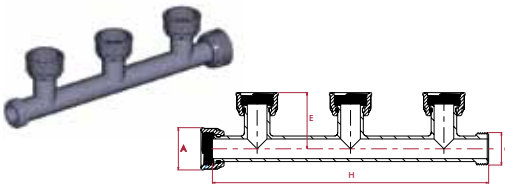

G	PN	REF.	CODE
1"	10	72 26 332	41859

A	E	H
43	57	281

UP. 26. MFD. 4OUT - MANIFOLD
4-outlet manifold

- 5 Female thread x 1 male thread

Colector PVC-U 4 salidas

- 5 Rosca hembra x 1 rosca macho

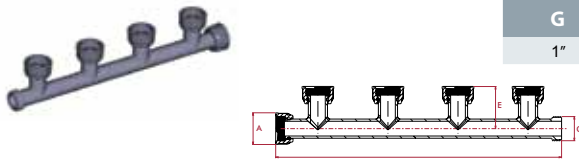

G	DN	PN	REF.	CODE
1"	20	10	72 26 432	41860

A	E	H
43	57	388

SIGHT GLASSES VISORES DE LÍQUIDOS

- Elemento necesario para mostrar el paso de líquido por una instalación, así como la visualización del estado del líquido (grado de turbidez).
- Dos modelos disponibles, con el visor en distintos materiales (PMMA o SAN).

- Elemento necesario para mostrar el paso de líquido por una instalación, así como la visualización del estado del líquido (grado de turbidez).
- Dos modelos disponibles, con el visor en distintos materiales (PMMA o SAN).

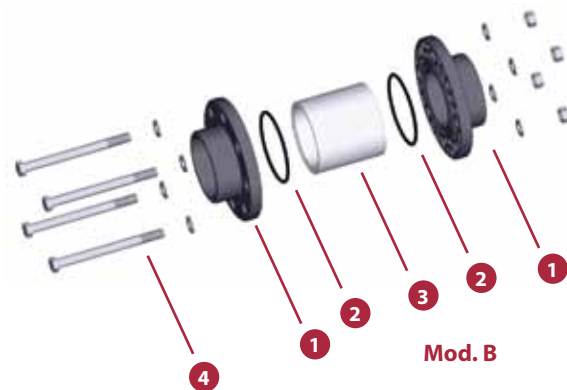
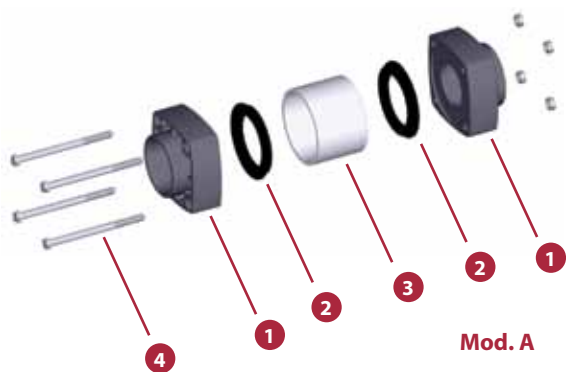
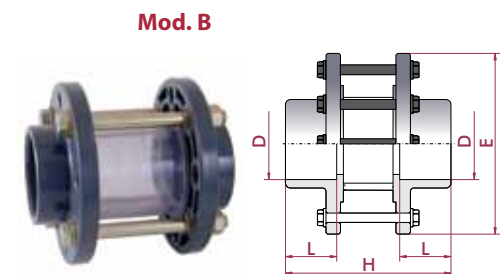
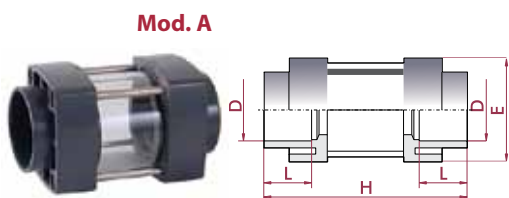

FIG.	Parts	Despiece	Material
1	Union / flange	Manguito / brida	PVC-U
2	O-ring	Junta	EPDM
3	Viewer	Visor	PMMA / SAN
4	Bolts	Tornillos	Zinc plated steel

UP. 54. SF

- Material:
D50 - D63: PMMA (Mod. A)
D75 - D225: SAN (Mod. B)
- 4 bolts
- Female solvent socket
- Metric series

- Material:
D50 - D63: PMMA (Mod. A)
D75 - D225: SAN (Mod. B)
- 4 tornillos
- Encolar hembra
- Serie métrica



D	DN	PN	REF.	CODE
50	40	6	05 54 050	02387
63	50	6	05 54 063	02388
75	65	10	05 54 075	02389
90	80	10	05 54 090	02390
110	100	10	05 54 110	02391
125	110	10	05 54 125	02392
140	125	10	05 54 140	02393
160	150	10	05 54 160	02394
200	175	10	05 54 200	02395
225	200	10	05 54 225	02396

L	H	E	Mod.
31	130	80	A
38	159	92	A
44	165	185	B
51	180	200	B
61	250	220	B
69	280	230	B
76	310	250	B
86	360	285	B
106	420	315	B
119	500	340	B

UP. 54. FT

- Material: PMMA
- 4 bolts
- BSP female thread

- Material: PMMA
- 4 tornillos
- Roscar hembra BSP

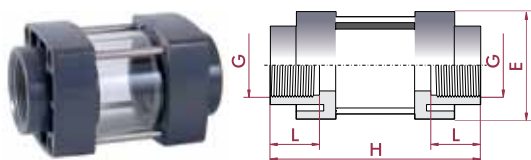

D	DN	PN	REF.	CODE
1½"	40	6	05 54 650	02397
2"	50	6	05 54 663	02398

L	H	E
31	130	80
38	159	92

FLOWMETERS - ROTAMETER

CAUDALÍMETROS - ROTÁMETROS

FEATURES

Flowmeters are transparent tubes with conical shape (narrow in its lower part and wider in the upper); they are installed in a perfectly vertical position along with the pipe of which we want to know the flow.

Within the tube there is a stainless steel floater, that will move upwards reaching a specific height depending on the weight of the floater and water pressure.

Thus, the greater is the flow, the higher will the floater move, marking a flow (l/h or GPM) in the scale which is stamped on the transparent tube.

- Available models from 10 to 1000 l/h (0,04 - 4,4 GPM).
- Assembly in vertical position.
- Union bushes in PVC-U.
- Tube in Styrene Methyl Methacrylate Copolymer.
- Measuring tube available in Polysulfon, Trogamid T[®], etc. upon request.
- Float stops in PVDF and floats in AISI 316.
- Maximum working temperature: 55°C (131°F) according to standards VDE / VDI 3531, class 6.
- Maximum pressure 15 bar.
- Two visible scales on each meter: l/h and GPM.
- Available upon request: limit switches and transmitters.
- Applications: process control in water treatment, osmosis, heating and refrigeration systems, chemical industries, pharmaceuticals, etc.

CARACTERÍSTICAS

Los caudalímetros son tubos transparentes con forma cónica (estrecho en su zona inferior y más ancho en su zona superior); se instalan en posición perfectamente vertical en serie con la tubería de la que se quiere conocer el caudal.

Dentro del tubo se encuentra un flotador de acero inoxidable, que se desplazará hacia arriba alcanzando una altura concreta que dependerá del peso del flotador y del empuje del agua.

Así, cuanto mayor es el caudal, más arriba se posicionará el flotador, marcando un caudal (l/h o GPM) en la escala que se encuentra marcada en el tubo transparente.

- Modelos disponibles desde 10 hasta 1000 l/h (0,04 - 4,4 GPM).
- Montaje en posición vertical.
- Racordaje en PVC-U.
- Tubo en metacrilato de metilo.
- Bajo pedido tubo de medida disponible en Polisulfon, Trogamid T[®], etc.
- Topes de flotador en PVDF.
- Flotador en AISI 316.
- Temperatura máxima de trabajo: 55°C (131°F) según normas VDE / VDI 3531, classe 6.
- Presiones hasta 15 bar.
- Doble escala visible en cada caudalímetro: l/h y GPM.
- Disponibles bajo pedido: automatismos y transmisores eléctricos.
- Aplicaciones: control de procesos en tratamiento de agua, osmosis, calefacción y refrigeración, industrias químicas, farmacéuticas, etc.

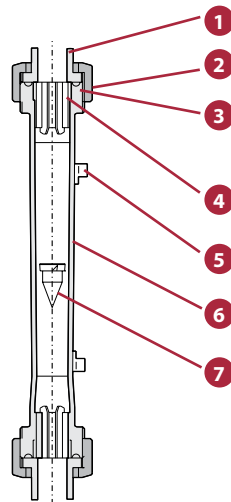
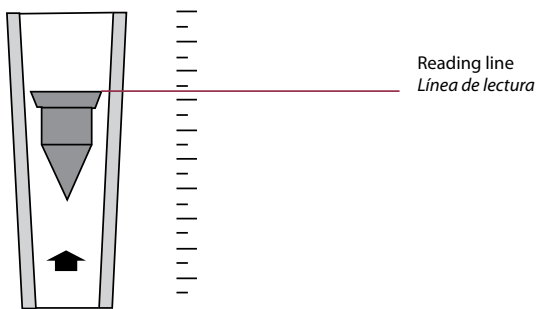

FIG.	Parts	Despiece	Material
1	Union end	Manguito enlace	PVC-U
2	Union nut	Tuerca	PVC-U
3	O-ring seal	Junta tórica	EPDM
4	Stops	Topes	PVDF
5	Indicator	Indicador	PE
6	Measuring tube	Tubo de medida	Methacrylate
7	Float	Flotador	AISI 316

OPERATION



FUNCIONAMIENTO

Chemical resistance chart
Tabla de resistencias químicas

Polymer type	Copolymer of styrene and methacrylate
Nomenclature	SMMA
CHEMICAL RESISTANCE	
Acetone	x
Unsaturated Oil	x
Saturated Oil	C
Mineral Oil	✓
Olive Oil	✓
Alcohol low molecular weight	C
Alcohol high molecular weight	✓
Diluted inorganic acid	✓
Concentrated inorganic acid	✓
Halogenated compound	x
Gasoline	x
Benzene	x
Toluene	x
Bleach	✓
Detergent	✓
Inorganic salts	✓

C: Conditioned resistance. In some cases the material may turn yellow, loose transparency or micro fissures could appear.

C: Resistencia condicional. En algunos casos puede darse amarillamiento, pérdida de la transparencia o formación de micro fisuras.

UP. 92. SF. M - FLOWMETER
Flowmeter

- Tube in Styrene Methyl Methacrylate Copolymer
- Female solvent socket

Caudalímetro

- Tubo en metacrilato de metilo
- Encolar hembra

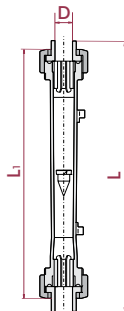

D	DN	REF.	CODE
20	15	05 92 020A	20205
20	15	05 92 020B	20206
20	15	05 92 020C	20207
25	20	05 92 025A	20208
25	20	05 92 025B	20209
25	20	05 92 025C	20210

GPM	l/h	L	L ₁
0,04 - 0,44	10 - 100	232	198
0,06 - 0,66	16 - 160	232	198
0,1 - 1,1	25 - 250	232	198
0,2 - 1,8	40 - 400	232	198
0,3 - 2,7	60 - 630	232	198
0,4 - 4,4	100 - 1000	232	198

UP. 92. FT. M - FLOWMETER
Flowmeter

- Tube in Styrene Methyl Methacrylate Copolymer
- BSP female thread

Caudalímetro

- Tubo en metacrilato de metilo
- Roscar hembra BSP

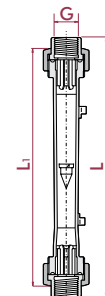

G	DN	REF.	CODE
½"	15	05 92 620A	20211
½"	15	05 92 620B	20212
½"	15	05 92 620C	20213
¾"	20	05 92 625A	20214
¾"	20	05 92 625B	20215
¾"	20	05 92 625C	20216

GPM	l/h	L	L ₁
0,04 - 0,44	10 - 100	232	198
0,06 - 0,66	16 - 160	232	198
0,1 - 1,1	25 - 250	232	198
0,2 - 1,8	40 - 400	232	198
0,3 - 2,7	60 - 630	232	198
0,4 - 4,4	100 - 1000	232	198

UP. 92. MT. M - FLOWMETER
Flowmeter

- Tube in Styrene Methyl Methacrylate Copolymer
- BSP male thread

Caudalímetro

- Tubo en metacrilato de metilo
- Roscar macho BSP

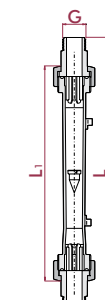

G	DN	REF.	CODE
½"	15	05 92 420A	20217
½"	15	05 92 420B	20218
½"	15	05 92 420C	20219
¾"	20	05 92 425A	20220
¾"	20	05 92 425B	20221
¾"	20	05 92 425C	20222

GPM	l/h	L	L ₁
0,04 - 0,44	10 - 100	249	198
0,06 - 0,66	16 - 160	249	198
0,1 - 1,1	25 - 250	249	198
0,2 - 1,8	40 - 400	252	198
0,3 - 2,7	60 - 630	252	198
0,4 - 4,4	100 - 1000	252	198

UP. 92. FLG. M - FLOWMETER
Flowmeter

- Tube in Styrene Methyl Methacrylate Copolymer
- With flanges

Caudalímetro

- Tubo en metacrilato de metilo
- Con bridas

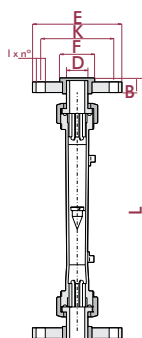

D	DN	REF.	CODE
20	15	05 92 220A	20223
20	15	05 92 220B	20224
20	15	05 92 220C	20225
25	20	05 92 225A	20226
25	20	05 92 225B	20227
25	20	05 92 225C	20228

GPM	l/h	E	K	F	lxn°	B	L
0,04 - 0,44	10 - 100	95	65	45	14x4	12	257
0,06 - 0,66	16 - 160	95	65	45	14x4	12	257
0,1 - 1,1	25 - 250	95	65	45	14x4	12	257
0,2 - 1,8	40 - 400	105	75	58	14x4	13	260
0,3 - 2,7	60 - 630	105	75	58	14x4	13	260
0,4 - 4,4	100 - 1000	105	75	58	14x4	13	260

SOLVENT CEMENT / CLEANER / PTFE TAPE

ADHESIVOS / DISOLVENTES / CINTA DE PTFE

NOTES ABOUT THE SOLVENT

- Carry out an accurate turnover of the stock as the solvent cement can lose the original characteristics after 12 months of its manufacture.
- Stock in a dry and fresh place.
- Please, read the instructions of use.
- Different solvent cements for PVC-U and PVC-C (read the description).
- If you want to read the solvent socket recommendations, please refer to Pipe installation Section

NOTAS SOBRE EL ADHESIVO

- Realizar una correcta rotación del stock ya que el adhesivo puede perder sus características originales a partir de los 12 meses de su fabricación.
- Almacenar en un lugar seco y fresco.
- Ver las normas de utilización del envase.
- Adhesivos diferenciados para PVC-U y PVC-C (ver descripción).
- Para ver las recomendaciones de instalación con adhesivo, consulte la Sección de Instalación de tubería.

Average joints for 1.000 cm³ of solvent cement
Nº aproximado de encoladuras efectuadas con 1.000 cm³ de adhesivo

Ø of pipe Ø de tubo	16	20	25	32	40	50	63	75	90	110	125	140	160	200	225	250	315	400
Nº of joints Nº de encoladuras	390	375	300	250	200	110	80	55	40	25	22	18	11	7	5	4	3	2

UP. 90. SC

CEPEX PVC-U solvent cement

Adhesivo PVC-U CEPEX



Size Medida	Vol.	REF.	CODE
Tub Tubo	125 cm ³	05 90 012	02429
Can with paint brush Bote con pincel	250 cm ³	05 90 026	02430
Can Bote	500 cm ³	05 90 050	02427
Can with paint brush Bote con pincel	500 cm ³	05 90 051	09043
Can Bote	1.000 cm ³	05 90 100	02426
Can with paint brush Bote con pincel	1.000 cm ³	05 90 101	09044

UP. 90. SCB

BONDITITE solvent cement PVC-U

- Fast action
- Especialmente indicado para tubo de PVC flexible

Adhesivo BONDITITE PVC-U

- Acción rápida
- Especialmente indicado para tubo de PVC flexible



Size Medida	Vol.	REF.	CODE
Can with paint brush Bote con pincel	250 cm ³	05 90 026B	27050
Can with paint brush Bote con pincel	500 cm ³	05 90 051B	27051
Can with paint brush Bote con pincel	1.000 cm ³	05 90 101B	27052

UP. 90. TSC

TANGIT solvent cement PVC-U

Adhesivo TANGIT PVC-U



Size Medida	Vol.	REF.	CODE
Can with paint brush Bote con pincel	500 cm ³	05 90 350	02434
Can Bote	1.000 cm ³	05 90 400	02433

UP. 90. SCU

UNI-100 solvent cement PVC-U

Adhesivo UNI-100 PVC-U



Size Medida	Vol.	REF.	CODE
Can with paint brush Bote con pincel	500 cm ³	05 90 051 UNI	52706
Can with paint brush Bote con pincel	1.000 cm ³	05 90 101 UNI	52707

UP. 90. SCH

HCR-36 solvent cement PVC-U / PVC-C

• High chemical resistance

Adhesivo HCR-36 PVC-U / PVC-C

• Alta resistencia química



Size Medida	Vol.	REF.	CODE
Can with paint brush Bote con pincel	1.000 cm ³	05 90 100 HCR	52711

Sulphuric acid: concentrations > 70%

Hydrochloric acid: concentrations > 25%

Nitric acid: concentrations > 20%

Lyes (caustic soda): concentrations > 35%

Fluoric acid: any concentration

Sodium hypochlorite: active chlorine content > 7.5%

CP. 90. SCH - PVC-C SOLVENT CEMENT

HT-120 solvent cement PVC-C

Adhesivo HT-120 PVC-C



Size Medida	Vol.	REF.	CODE
Can with paint brush Bote con pincel	500 cc	36 90 051	52708

ABS. 90. SCG

B-25 grey ABS solvent cement

• Up to D315

• Max. 15 bar

• Maximum tolerance 0.6 mm diametrical clearance

Adhesivo ABS B-25 gris

• Hasta D315

• Max. 15 bar

• Tolerancia máxima 0.6 mm en diámetro



Size Medida	Vol.	REF.	CODE
Can with paint brush Bote con pincel	500 cm ³	05 90 051 GR	52710

UP. 90. CL

Cleaner

Disolvente



Size Medida	Vol.	REF.	CODE
Can Bote	500 cm ³	05 90 250	02432
Can Bote	1.000 cm ³	05 90 300	02431

UP. 90. TF

PTFE thread-wrap tape

Cinta de PTFE



Thickness Grueso	Width Anchura	Length Largo	REF.	CODE
0,075 mm	12 mm	12 m	05 90 500	02435
0,10 mm	19 mm	50 m	05 90 550	02436

BRITISH STANDARD SERIES

ELBOWS <i>CODOS</i>	01	PAG. 113
TEES <i>TÉS</i>	02	PAG. 114
SOCKETS AND REDUCERS <i>MANGUITOS Y REDUCCIONES</i>	03	PAG. 114
FLANGES <i>BRIDAS</i>	04	PAG. 115
CAPS <i>TAPONES</i>	05	PAG. 116
NIPPLES <i>MACHONES</i>	06	PAG. 116
UNIONS <i>ENLACES 3 PIEZAS</i>	07	PAG. 117
SIGHT GLASSES <i>VISORES DE LÍQUIDOS</i>	08	PAG. 120

TECHNICAL CHARACTERISTICS

CARACTERÍSTICAS TÉCNICAS

Unions <i>Uniones</i>	Sizes <i>Medidas</i>	Working pressure at 20°C <i>Presión de servicio a 20°C</i>
Solvent socket / <i>Encolar</i>	½" - 4"	PN 16 (240 psi)
Threaded / <i>Roscar</i>	½" - 2"	PN 10 (150 ps)

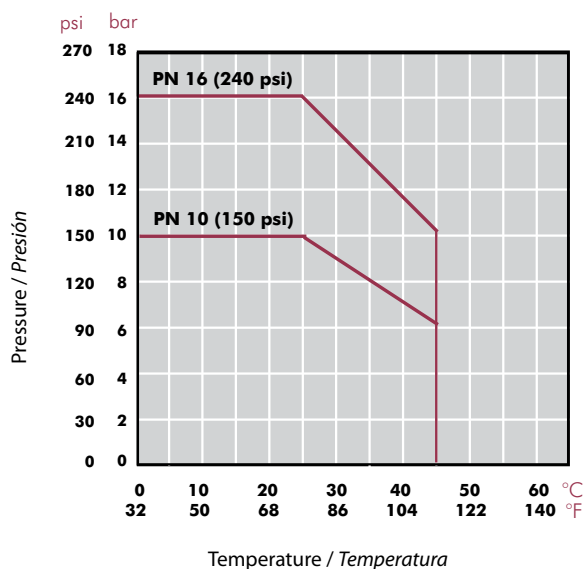
 PRESSURE / TEMPERATURE GRAPH
 DIAGRAMA PRESIÓN / TEMPERATURA

Life: 50 years
 Hydrostatic maximum pressure a component may withstand in continuous service (without overpressure)

Vida útil: 50 años
Presión hidrostática máxima que un componente es capaz de soportar en servicio continuo (sin sobrepresión)

TOLERANCE CHART

TABLA TOLERANCIAS

DN	Minimum diameter <i>Diámetro mínimo</i>	Maximum diameter <i>Diámetro máximo</i>
3/8"	17.1	17.3
1/2"	21.3	21.5
3/4"	26.7	26.9
1"	33.5	33.7
1¼"	42.2	42.4
1½"	48.2	48.4
2"	60.3	60.5
2½"	75.1	75.3
3"	88.8	89.1
4"	114.2	114.5
5"	140.1	140.4
6"	168.2	168.5
7"	193.7	194.0
8"	219.0	219.4

ELBOWS

CODOS

UP. 01. SF. BS - 90° ELBOW BS

- 90° elbow**
- Female solvent socket
 - British Standard Series

- Codo 90°**
- Encolar hembra
 - Serie British Standard

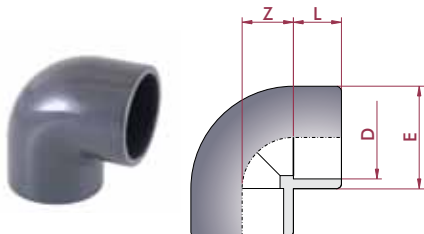

D	DN	PN	REF.	CODE
½"	15	16	05 01 901	07137
¾"	20	16	05 01 902	07138
1"	25	16	05 01 903	07139
1¼"	32	16	05 01 904	07140
1½"	40	16	05 01 905	07141
2"	50	16	05 01 906	07142
2½"	65	16	05 01 075 ^M	07178
3"	80	16	05 01 908	07144
4"	100	16	05 01 910	07145

L	Z	E
16	11	27
19	14	33
22	17	41
26	21	50
31	26	61
38	33	76
44	39	90
51	46	108
61	56	131

UP. 01. SFT. BS - 90° ELBOW BS

- 90° adaptor elbow**
- Female solvent socket & BSP female thread
 - British Standard series

- Codo 90° mixto**
- Encolar hembra y roscar hembra BSP
 - Serie British Standard

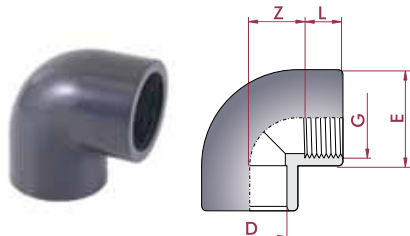

D x G	DN	PN	REF.	CODE
½" x ½"	15	10	05 01 931	07146
¾" x ¾"	20	10	05 01 932	07147
1" x 1"	25	10	05 01 933	07148
1¼" x 1¼"	32	10	05 01 934	07149
1½" x 1½"	40	10	05 01 935	07150
2" x 2"	50	10	05 01 936	07151

L	Z	E
14	11	27
16	14	33
19	17	41
20	21	50
20	26	61
24	33	76

UP. 02. SF. BS - 45° ELBOW BS

- 45° elbow**
- Female solvent socket
 - British Standard series

- Codo 45°**
- Encolar hembra
 - Serie British Standard

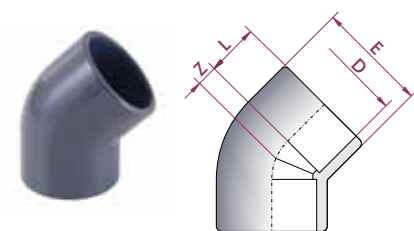

D	DN	PN	REF.	CODE
½"	15	16	05 02 901	07152
¾"	20	16	05 02 902	07153
1"	25	16	05 02 903	07154
1¼"	32	16	05 02 904	07155
1½"	40	16	05 02 905	07156
2"	50	16	05 02 906	07157
2½"	65	16	05 02 075 ^M	07152
3"	80	16	05 02 908	07159
4"	100	16	05 02 910	07160

L	Z	E
16	5	28
19	6	35
22	8	43
26	10	52
31	12	61
38	14	76
44	17	93
51	20	109
61	24	133

UP. 02. SFT. BS - 45° ELBOW BS

- 45° adaptor elbow**
- Female solvent socket & BSP female thread
 - British Standard series

- Codo 45° mixto**
- Encolar hembra y roscar hembra BSP
 - Serie British Standard

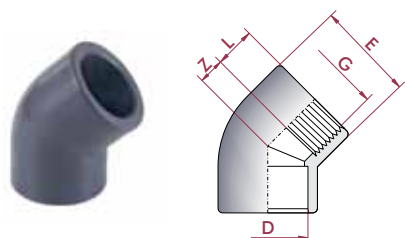

D x G	DN	PN	REF.	CODE
½" x ½"	15	10	05 02 931	07161
¾" x ¾"	20	10	05 02 932	07162
1" x 1"	25	10	05 02 933	07163
1¼" x 1¼"	32	10	05 02 934	07164
1½" x 1½"	40	10	05 02 935	07165
2" x 2"	50	10	05 02 936	07166

L	Z	E
14	5	28
16	6	34
19	8	43
20	10	54
20	12	63
24	14	78

TEES

TÉS

UP. 03. SF. BS - 90° TEE BS

90° tee

- Female solvent socket
- British Standard series

Té 90°

- Encolar hembra
- Serie British Standard

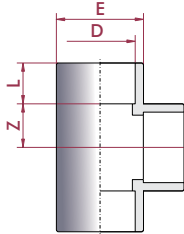

D	DN	PN	REF.	CODE
½"	15	16	05 03 901	07167
¾"	20	16	05 03 902	07168
1"	25	16	05 03 903	07169
1¼"	32	16	05 03 904	07170
1½"	40	16	05 03 905	07171
2"	50	16	05 03 906	07172
2½"	65	16	05 03 075 ^M	01786
3"	75	16	05 03 908	07174
4"	80	16	05 03 910	07175

L	Z	E
16	11	27
19	14	33
22	17	41
26	21	50
31	26	61
38	33	76
44	39	90
51	46	108
61	56	131

UP. 03. SFT. BS - 90° TEE BS

90° adaptor tee

- Female solvent socket & BSP female thread
- British Standard series

Té 90° mixta

- Encolar hembra y roscar hembra BSP
- Serie British Standard

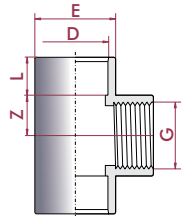

D x G	DN	PN	REF.	CODE
½" x ½"	15	10	05 03 931	07176
¾" x ¾"	20	10	05 03 932	07177
1" x 1"	25	10	05 03 933	07178
1¼" x 1¼"	32	10	05 03 934	07179
1½" x 1½"	40	10	05 03 935	07180
2" x 2"	50	10	05 03 936	07181

L	Z	E
14	11	27
16	14	33
19	17	41
20	21	50
20	26	61
24	33	76

SOCKETS

MANGUITOS UNIÓN

UP. 05. SF. BS - SOCKET BS

Socket

- Female solvent socket
- British Standard series

Manguito unión

- Encolar hembra
- Serie British Standard

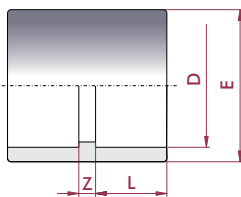

D	DN	PN	REF.	CODE
½"	15	16	05 05 901	07182
¾"	20	16	05 05 902	07183
1"	25	16	05 05 903	07184
1¼"	32	16	05 05 904	07185
1½"	40	16	05 05 905	07186
2"	50	16	05 05 906	07187
2½"	65	16	05 05 075 ^M	01878
3"	80	16	05 05 908	07189
4"	100	16	05 05 910	07190

L	Z	E
16	3	27
19	3	33
22	3	41
26	3	50
31	3	61
38	3	75
44	4	90
51	5	108
61	6	131

UP. 05. SFT. BS - SOCKET BS

Adaptor socket

- Female solvent socket & BSP female thread
- British Standard series

Manguito unión mixto

- Encolar hembra y roscar hembra BSP
- Serie British Standard

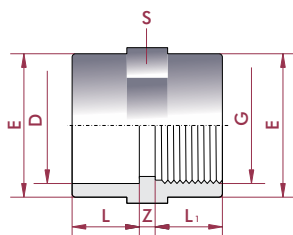

D x G	DN	PN	REF.	CODE
½" x ½"	15	10	05 05 931	07191
¾" x ¾"	20	10	05 05 932	07192
1" x 1"	25	10	05 05 933	07193
1¼" x 1¼"	32	10	05 05 934	07194
1½" x 1½"	40	10	05 05 935	07195
2" x 2"	50	10	05 05 936	07196
2½" x 2½"	65	10	05 05 475 ^M	01895

L	L ₁	Z	E	S
16	14	3	27	27
19	16	3	33	33
22	19	3	41	41
26	20	3	50	50
31	20	3	61	61
38	24	3	75	75
44	44	4	90	90

UP. 27. SF. MBS - ADAPTOR SOCKET METRIC - BS

Metric/BS adaptor socket

- Female solvent socket
- British Standard - Metric series

Manguito adaptador métrico/BS

- Encolar hembra
- Serie British Standard - Métrica

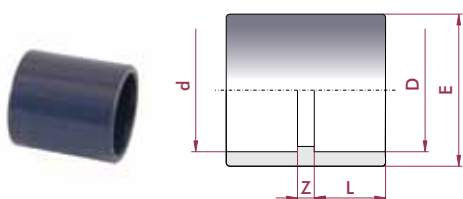

D x d	DN	PN	REF.	CODE
20 x 1/2"	15	16	05 27 901	07229
25 x 3/4"	20	16	05 27 902	07230
32 x 1"	25	16	05 27 903	07231
40 x 1 1/4"	32	16	05 27 904	07232
50 x 1 1/2"	40	16	05 27 905	07233
63 x 2"	50	16	05 27 906	07234
90 x 3"	80	16	05 27 908	07236
110 x 4"	100	16	05 27 910	07237

L	Z	E
16	3	27
19	3	33
22	3	41
26	3	50
31	3	61
38	3	75
51	5	108
61	6	135

REDUCERS

REDUCCIONES

UP. 06. SMF. BS - REDUCING BUSH BS

Reducing bush

- Male x female solvent socket
- British Standard series

Casquillo reducción

- Encolar macho x hembra
- Serie British Standard

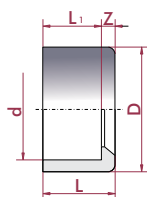

D x d	DN	PN	REF.	CODE
3/4" x 1/2"	15	16	05 06 920	07198
1" x 3/4"	20	16	05 06 930	07199
1" x 1/2"	15	16	05 06 931	07200
1 1/4" x 1"	25	16	05 06 940	07201
1 1/4" x 3/4"	20	16	05 06 941	07202
1 1/2" x 1 1/4"	32	16	05 06 950	07203
1 1/2" x 1"	25	16	05 06 951	07204
2" x 1 1/2"	40	16	05 06 960	07205
2 1/2" x 2"	50	16	05 06 970	07206
3" x 2 1/2"	65	16	05 06 980	07207
4" x 3"	80	16	05 06 990	07208

L	L ₁	Z
19	16	3
22	19	3
22	16	6
26	22	4
26	19	7
31	26	5
31	22	9
38	31	7
44	38	6
51	44	7
61	51	10

FLANGES

BRIDAS

UP. 10. SF. BS - FLANGE ADAPTOR BS

PVC-U flange adaptor (sub flange)

- Female solvent socket
- British Standard series
- To check the dimensions of flanges, see UP. 11. FLG in the Metric series chapter.

Manguito portabridas PVC-U

- Encolar hembra
- Serie British Standard
- Dimensiones de las bridas: ver UP. 11. FLG en el apartado de medida métrica

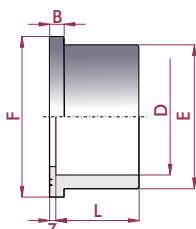

D	DN	PN	REF.	CODE
2"	50	16	05 10 906	07804
2 1/2"	65	16	05 10 075 ^M	02022
3"	80	16	05 10 908	07218
4"	100	16	05 10 910	07219
5"	125	16	05 10 140 ^M	02026
6"	150	10	05 10 914	07221
8"	200	10	05 10 917	07222

L	Z	B	E	F
38	3	9	76	90
44	3	10	90	106
51	5	11	108	125
61	5	12	131	150
76	5	14	165	188
86	5	16	188	213
119	6	25	248	274

CAPS

TAPONES

UP. 07. SF. BS - CAP BS

Cap

- Female solvent socket
- British Standard series

Tapón

- Encolar hembra
- Serie British Standard

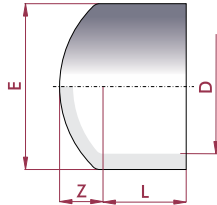

D	DN	PN	REF.	CODE
½"	15	16	05 07 901	07209
¾"	20	16	05 07 902	07210
1"	25	16	05 07 903	07211
1¼"	32	16	05 07 904	07212
1½"	40	16	05 07 905	07213
2"	50	16	05 07 906	07214
2½"	65	16	05 07 075 ^{MA}	01949
3"	80	16	05 07 908	07216
4"	100	16	05 07 910	07803

L	Z	E
16	8	26
19	9	33
22	10	40
26	12	50
31	15	63
38	17	75
44	19	90
51	23	110
61	28	131

NIPPLES

MACHONES

UP. 15. SFMT. BS - ADAPTOR NIPPLE BS

Adaptor nipple

- Female/male solvent socket & BSP male thread
- British Standard series

Machón mixto

- Encolar hembra/macho y rosca macho BSP
- Serie British Standard

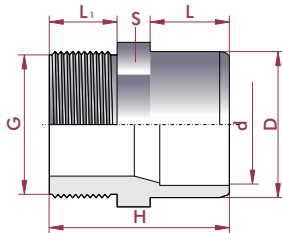

D - d x G	DN	PN	REF.	CODE
½" - ¾" x ½"	15	10	05 15 931	07238
¾" - ½" x ¾"	20	10	05 15 932	07239
1" - ¾" x 1"	25	10	05 15 933	07240
1¼" - 1" x 1¼"	32	10	05 15 934	07241
1½" - 1¼" x 1½"	40	10	05 15 935	07242
2" - 1½" x 2"	50	10	05 15 936	07243
2½" - 2" x 2½"	65	10	05 15 475 ^{MA}	02091
3" - 2½" x 3"	80	10	05 15 938	07245

L	L ₁	H	S
16	14	42	27
19	16	47	32
22	19	54	36
26	21	60	46
31	25	70	55
38	25	78	65
44	30	89	78
51	33	99	93

UP. 17. SFMT. BS - ADAPTOR BUSH BS

Adaptor bush

- Female solvent socket x BSP male threaded
- British Standard series

Terminal rosca macho

- Encolar hembra x rosca macho BSP
- Serie British Standard

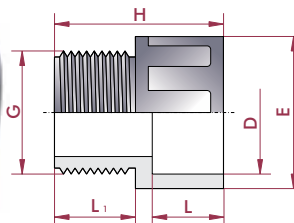

D x G	DN	PN	REF.	CODE
½" x ½"	15	10	05 17 931	07246
¾" x ¾"	20	10	05 17 932	07247
1" x 1"	25	10	05 17 933	07248
1¼" x 1¼"	32	10	05 17 934	07249
1½" x 1½"	40	10	05 17 935	07250
2" x 2"	50	10	05 17 936	07251
2½" x 2½"	65	10	05 17 475 ^{MA}	02108
3" x 3"	80	10	05 17 938	07253
4" x 4"	100	10	05 17 940	07254

L	L ₁	E	H
16	14	28	38
19	16	34	42
22	19	41	50
26	21	51	55
31	30	62	65
38	30	77	75
44	30	90	85
51	33	108	98
61	40	131	115

PVC-U UNIONS

ENLACES 3 PIEZAS PVC-U

Unions are the preferred choice over flange adaptors for the connection of plastic pipes. With no metal parts, there is no corrosion and the weight is also reduced.

They are only available in small sizes (up until D110).

The union ends are manufactured in plain ends for solvent socket or thread always according the sizing standards, doing this system appropriate to adapt to other elements or systems. Cepex unions feature an o-ring in order to ensure better unions, so it is not needed the use of PTFE tape between nut and union end (it is only needed in the threaded ends).

They are not recommended when connected to pipe under bending stress.

The union nut should be tightened by hand. Must use a strap wrench for big sizes (D75, D90, D110).

With this type of unions, it is possible to mix several plastic materials.

Cuando hay que unir plásticos, éstos son preferidos a las bridas, ya que no contienen ninguna parte de metal y el diámetro exterior es más reducido.

En contrapartida sólo están disponibles para diámetros pequeños (hasta D110).

Los manguitos de conexión están fabricados en terminaciones lisas de encolado o roscadas, siempre bajo normativas standards, haciendo posible la adaptación a otros componentes (incluso de materiales distintos).

Los enlaces 3 piezas Cepex incorporan junta para asegurar estanqueidad entre los dos manguitos de la unión, por lo que no debe usarse cinta de PTFE entre tuerca y manguito (usar cinta de PTFE solamente en las terminaciones de manguito roscadas). No son recomendables cuando el tubo tenga que estar sometido a fuerza de flexión (debido a posibles desalineaciones).

No es necesario el uso de ninguna herramienta, se rosca con las manos. Usar llave de cinta en diámetros grandes (D75, D90, D110).

Mediante estos enlaces, se pueden combinar diferentes tipos de plásticos.



CONNECTION POSSIBILITIES

POSIBILIDADES DE CONEXIÓN

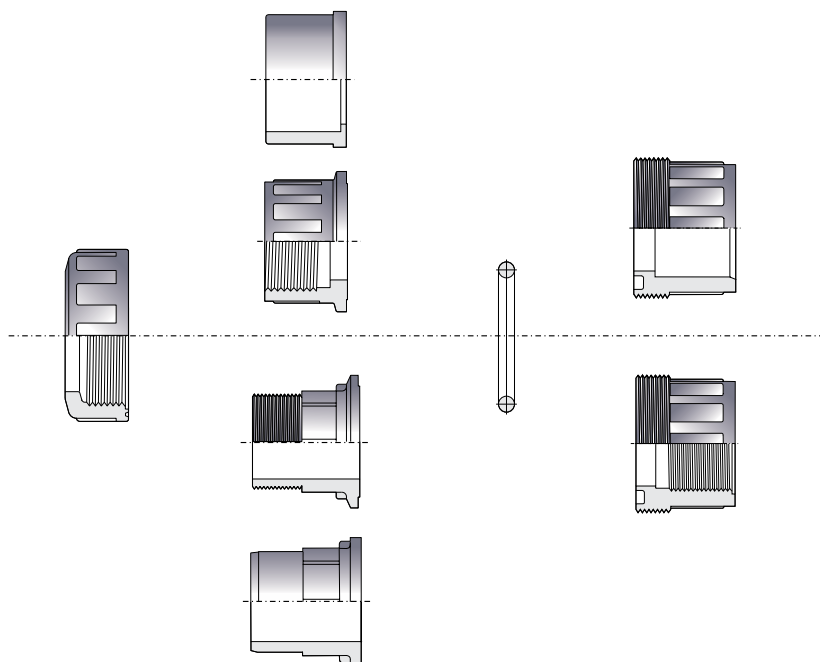

Available standards

Solvent socket: metric, BS, ASTM

Threaded: BSP, NPT

Standards disponibles

Encolar: métrico, BS, ASTM

Roscar: BSP, NPT

Ask for other types of unions or other materials (PP, PE100...)

Consultar otros tipos de conexión o materiales (PP, PE100...)

UP. 50. SF. BS - UNION BS

Union

- Female solvent socket
- British Standard series
- EPDM O-Ring

Enlace 3 piezas

- Encolar hembra
- Serie British Standard
- Anillo tórico en EPDM

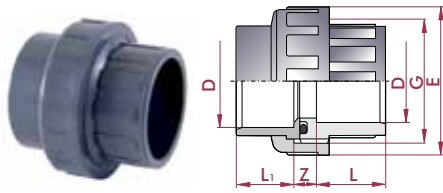

D	DN	PN	REF.	CODE
½"	15	16	05 50 901	07332
¾"	20	16	05 50 902	07333
1"	25	16	05 50 903	07334
1¼"	32	16	05 50 904	07335
1½"	40	16	05 50 905	07336
2"	50	16	05 50 906	07337
2½"	65	10	05 50 075 ^M	02333
3"	80	10	05 50 908	07806
4"	100	10	05 50 910	07807

L	Z	G	E	o-ring
16	13	1"	41	20 x 3
19	13	1¼"	52	38 x 3
22	13	1½"	60	33 x 3
26	15	2"	74	41 x 5
31	17	2¼"	80	47 x 5
38	21	2¾"	99	60 x 5
44	21	3½"	120	76 x 5
51	24	4"	138	91 x 5
61	26	5½"	179	110 x 5

UP. 50. SFT. BS - UNION BS

Union adaptor

- Female solvent socket x BSP female thread
- British Standard series
- EPDM O-Ring

Enlace 3 piezas

- Encolar hembra x roscar hembra BSP
- Serie British Standard
- Anillo tórico en EPDM

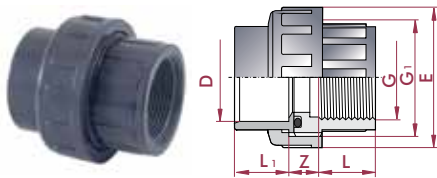

D x G	DN	PN	REF.	CODE
½" x ½"	15	16	05 50 931	07255
¾" x ¾"	20	16	05 50 932	07256
1" x 1"	25	16	05 50 933	07257
1¼" x 1¼"	32	16	05 50 934	07258
1½" x 1½"	40	16	05 50 935	07259
2" x 2"	50	16	05 50 936	07260
2½" x 2½"	65	10	05 50 475 ^M	02342
3" x 3"	80	10	05 50 938	07808
4" x 4"	100	10	05 50 940	07809

L	Z	G ₁	E	o-ring
16	13	1"	41	20 x 3
19	13	1¼"	52	28 x 3
22	13	1½"	60	33 x 3
26	15	2"	74	41 x 5
31	17	2¼"	90	47 x 5
38	21	2¾"	108	60 x 5
44	21	3½"	120	76 x 5
51	24	4"	138	91 x 5
61	26	5½"	179	110 x 5

UP. 51. SMT. BS - UNION BS

Union adaptor

- Female solvent socket x BSP male thread
- British Standard series
- EPDM O-Ring

Enlace 3 piezas

- Encolar hembra x roscar macho BSP
- Serie British Standard
- Anillo tórico en EPDM

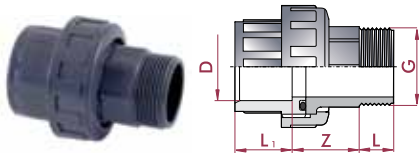

D x G	DN	PN	REF.	CODE
½" x ½"	15	16	05 51 931	07810
¾" x ¾"	20	16	05 51 932	07811
1" x 1"	25	16	05 51 933	07812
1¼" x 1¼"	32	16	05 51 934	07813
1½" x 1½"	40	16	05 51 935	07262
2" x 2"	50	16	05 51 936	07263
2½" x 2½"	65	10	05 51 475 ^M	02359
3" x 3"	80	10	05 51 938	07814
4" x 4"	100	10	05 51 940	07815

L ₁	L	Z
16	15	33
19	16	35
22	19	40
26	21	40
31	21	48
38	25	62
44	30	70
51	33	62
61	39	70

UP. 57. SFMT. BS - UNION BS

Self-align union

- Max. misalignment ±4°
- Female solvent socket x BSP male thread
- British Standard series

Manguito orientable

- Dealineación max. ±4°
- Encolar hembra x roscar macho BSP
- Serie British Standard

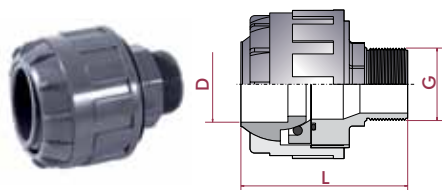

D x G	DN	PN	REF.	CODE
1½" x 1½"	40	10	05 57 955	21081

L
110

FITTINGS FOR UNIONS

ACCESORIOS ENLACES 3 PIEZAS

UP. 21. MFT - UNION BUSH BS

Union bush
• BSP male x female thread

Manguito enlace
• Roscar macho x hembra BSP

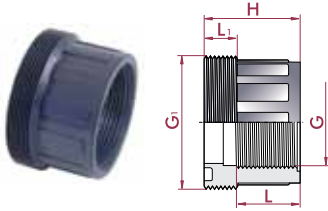

G ₁ x G	DN	PN	REF.	CODE
1" x 1/2"	15	10	05 21 620	02160
1 1/4" x 3/4"	20	10	05 21 625	02162
1 1/2" x 1"	25	10	05 21 632	02163
2" x 1 1/4"	32	10	05 21 640	02165
2 1/4" x 1 1/2"	40	10	05 21 650	02166
2 3/4" x 2"	50	10	05 21 663	02168
3 1/2" x 2 1/2"	65	10	05 21 675	02169
4" x 3"	80	10	05 21 690	02170
5 1/2" x 4"	100	10	05 21 710	02171

L	L ₁	H
16	10	26
19	11	29
22	12	32
30	15	39
34	16	46
38	18	56
44	18	62
51	18	69
61	31	79

UP. 22. SF. BS - UNION END BS

Union end
• Female solvent socket
• British Standard series

Manguito enlace
• Encolar hembra
• Serie British Standard

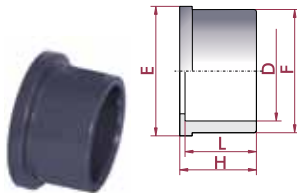

D	DN	PN	REF.	CODE
1/2"	15	16	05 22 901	27254
3/4"	20	16	05 22 902	27255
1"	25	16	05 22 903	27256
1 1/4"	32	16	05 22 904	27257
1 1/2"	40	16	05 22 905	27258
2"	50	16	05 22 906	27259
2 1/2"	65	16	05 22 075*	02178
3"	80	16	05 22 908	27260
4"	100	16	05 22 910	27261

L	E	H	F
16	30	19	27
19	39	22	36
22	45	25	41
26	56	29	53
31	63	34	59
38	78	41	74
44	97	47	92
51	110	56	105
61	147	66	131

UP. 22. MT- UNION END BS

Union end
• BSP male thread

Manguito enlace
• Roscar macho BSP

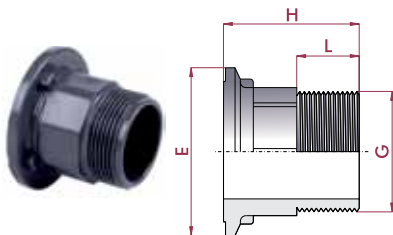

G	DN	PN	REF.	CODE
1/2"	15	10	05 22 420	25960
3/4"	20	10	05 22 425	25961
1"	25	10	05 22 432	25962
1 1/4"	32	10	05 22 440	25963
1 1/2"	40	10	05 22 450	25964
2"	50	10	05 22 463	25965
2 1/2"	65	10	05 22 475	25966
3"	80	10	05 22 490	25967
4"	100	10	05 22 510	25968

L	H	E
15	38	30
16	41	39
19	48	45
21	50	57
21	57	63
28	70	78
30	72	97
33	77	110
40	98	147

UP. 23. FT- UNION NUT BS

Union nut
• BSP female thread

Tuerca
• Roscar hembra BSP

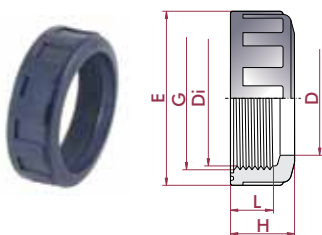

G	PN	REF.	CODE
1"	10	05 23 632	02188
1 1/4"	10	05 23 640	02189
1 1/2"	10	05 23 650	02191
2"	10	05 23 663	02192
2 1/4"	10	05 23 664	02193
2 3/4"	10	05 23 676	02196
3 1/2"	10	05 23 692	02197
4"	10	05 23 710	02198
5 1/2"	10	05 23 741	02199

L	H	E	D	Di
15	20	41	27	30
16	22	52	36	39
20	26	60	41	45
21	26	74	53	57
22	30	80	59	63
28	36	99	74	78
28	36	120	92	97
28	38	133	105	110
41	56	177	131	148

SIGHT GLASSES

VISORES DE LÍQUIDOS

UP. 54. SF. BS- SIGHT GLASSES BS

- Material:
 - 1½" - 2": PMMA (Fig. A)
 - 2½" - 4": SAN (Fig. B)
- 4 bolts
- Female solvent socket
- British Standard series

- Material:
 - 1½" - 2": PMMA (Fig. A)
 - 2½" - 4": SAN (Fig. B)
- 4 tornillos
- Encolar hembra
- Serie British Standard

Working pressure at 20°C (73°F) water temperature:

- 1½" - 2": PN 6
- 2½" - 4": PN 10

Presión de servicio a 20°C (73°F) temperatura de agua:

- 1½" - 2": PN 6
- 2½" - 4": PN 10

Mod. A

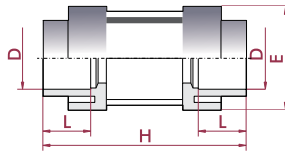

D	DN	PN	REF.	CODE
1½"	40	6	05 54 905	21082
2"	50	6	05 54 906	21083
2½"	65	10	05 54 075 ^M	02389
3"	80	10	05 54 908	21084
4"	100	10	05 54 910	21085

L	H	E	Mod.
31	130	80	A
38	159	92	A
44	165	185	B
51	180	200	B
61	250	220	B

Mod. B

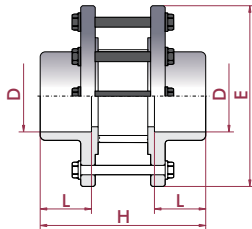

AMERICAN SIZES SERIES

SOCKETS <i>MANGUITOS</i>	01	PAG. 123
FLANGES <i>BRIDAS</i>	02	PAG. 124
UNIONS <i>ENLACES 3 PIEZAS</i>	03	PAG. 126

TECHNICAL CHARACTERISTICS
CARACTERÍSTICAS TÉCNICAS

Unions Uniones	Sizes Medidas	Working pressure at 20°C Presión de servicio a 20°C
Solvent socket / Encolar	½" - 4"	PN 16 (240 psi)
Threaded / Roscar	½" - 4"	PN 10 (150 ps)

PRESSURE / TEMPERATURE GRAPH
DIAGRAMA PRESIÓN / TEMPERATURA

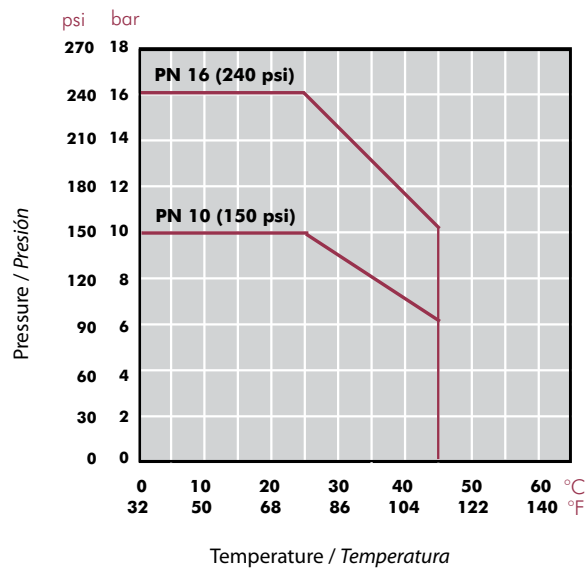

Life: 50 years
Hydrostatic maximum pressure a component may withstand in continuous service (without overpressure)

Vida útil: 50 años
Presión hidrostática máxima que un componente es capaz de soportar en servicio continuo (sin sobrepresión)

TOLERANCE CHART
TABLA TOLERANCIAS

DN	Inlet diameter Diámetro en entrada		Bottom diameter Diámetro en fondo	
	MIN.	MAX.	MIN.	MAX.
3/8"	17.35	17.55	16.94	17.14
1/2"	21.44	21.64	21.13	21.33
3/4"	26.77	26.97	26.47	26.67
1"	33.53	33.78	33.14	33.40
1¼"	42.29	42.55	41.91	42.17
1½"	48.41	48.71	47.96	48.26
2"	60.48	60.78	60.02	60.32
2½"	73.20	73.56	72.67	73.03
3"	89.11	89.51	88.50	88.90
4"	114.53	114.99	113.84	114.30
5"	141.56	142.06	140.80	141.30
6"	168.55	169.11	167.72	168.28
8"	219.46	220.22	218.32	219.08

UP. 27. SF. MMA - ADAPTOR SOCKET METRIC - MA

Metric/ASTM adaptor socket

- Female solvent socket
- ASTM - Metric series

Manguito adaptador métrico/ASTM

- Encolar hembra
- Serie ASTM - Métrica

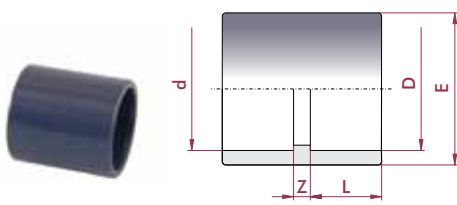

D x d	DN	PN	REF.	CODE
20 x 1/2"	15	16	05 27 901 MA	60257
25 x 3/4"	20	16	05 27 902 MA	64467
32 x 1"	25	16	05 27 903 MA	64468
40 x 1 1/4"	32	16	05 27 904 MA	64496
50 x 1 1/2"	40	16	05 27 905 MA	64497
63 x 2"	50	16	05 27 906 MA	64498
75 x 2 1/2"	65	16	05 27 907 MA	64499
90 x 3"	80	16	05 27 908 MA	64500
110 x 4"	100	16	05 27 910 MA	64501

L	Z	E
16	3	27
19	3	33
22	3	41
26	3	50
31	3	61
38	3	75
44	4	90
51	5	108
61	6	135

PVC-U LOOSE FLANGES

BRIDAS LOCAS PVC-U

• ANSI ASME B16.5 | ANSI ASME 16.5/16.34 Flange System.
 • We recommend to follow flange installation instructions carefully to avoid any unnecessary tensions.

• Sistema de bridas ANSI ASME B16.5 | ANSI ASME 16.5/16.34.
 • Recomendamos seguir exactamente las normas de montaje de bridas con objeto de evitar tensiones innecesarias.

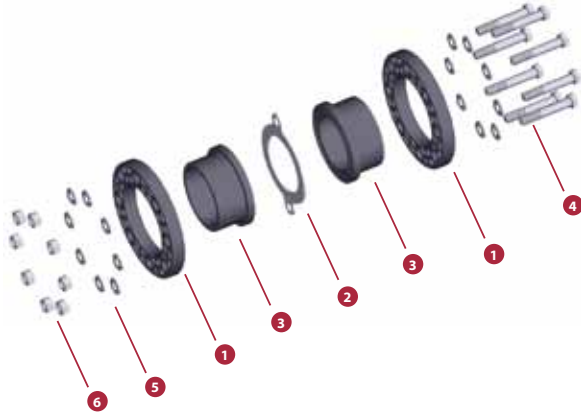

D	1 PVC-U	3 PVC-U
2½"	✓	✓
3"	✓	✓
4"	✓	✓
5"	✓	✓
6"	✓	✓
8"	✓	✓

FIG.	Parts	Despiece	Material
1	Flange	Brida	PVC-U / PP
2	Flat gasket	Junta plana	EVA / EPDM
3	Flange adaptor **	Manguito portabridas **	PVC-U
4	Screw DIN 931	Tornillo DIN 931	5,6 Zinc plated steel / A2 Stainless steel *
5	Washer DIN 125-A	Arandela DIN 125-A	
6	Nut DIN 934	Tuerca DIN 934	

* On order A4 Stainless steel
 Bajo pedido acero inoxidable A4

** Flange adaptor available in BS and ASTM solvent socket standards
 Manguito portabridas disponible en standards BS y ASTM

TIGHTENING SEQUENCE

ORDEN DE APRIETE

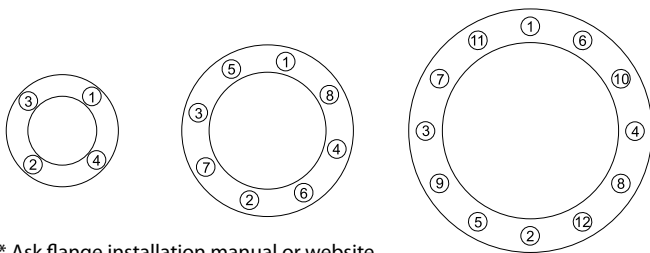

* Ask flange installation manual or website
 Consultar manual instalación bridas o website

TIGHTENING MAXIMUM TORQUE

MÁXIMO PAR DE APRIETE

D	DN	inch	N · m	Kgf · cm	inch · lbs
63-75	65	2 ½"	25	255	221
90	80	3"	25	255	221
110	100	4"	30	306	265
125-140	125	5"	35	257	310
160	150	6"	40	408	354
200-225	200	8"	50	510	442
250-280	250	10"	80	816	708
315	300	12"	80	816	708

UP. 10. SF. MA - FLANGE ADAPTOR MA

PVC-U flange adaptor (sub flange)

- Female solvent socket
- ASTM series

Manguito portabridas PVC-U

- Encolar hembra
- Serie ASTM

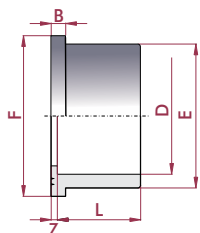

D	DN	PN	REF.	CODE
2"	50	16	05 10 906 MA	66836
2½"	65	16	05 10 907 MA	07097
3"	80	16	05 10 908 MA	07098
4"	100	16	05 10 910 MA	07099
5"	125	16	05 10 913 MA	07100
6"	150	10	05 10 914 MA	07101
8"	175	10	05 10 917 MA	07102

L	Z	B	E	F
38	3	9	76	90
44	3	10	90	106
51	5	11	108	125
61	5	12	131	150
76	5	14	165	188
86	5	16	188	213
106	6	20	225	247

UP. 11. FLG - FLANGE

PVC-U loose flange

Brida loca PVC-U

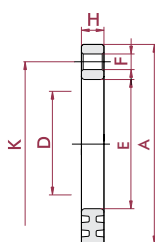

D	DN	PN	REF.	CODE
3"	80	16	05 99 104	0599104
4"	100	16	05 99 105	0599105
6"	150	16	05 99 106	0599106
8"	175	16	05 99 107	0599107

E	A	H	K	F
110	200	23	150-159	8 x 19
133	230	28	175-190,5	8 x 19,5
190	285	32	240,2	8 x 23
250	343	38	290-298	8 x 23

PVC-U UNIONS

ENLACES 3 PIEZAS PVC-U

Unions are the preferred choice over flange adaptors for the connection of plastic pipes. With no metal parts, there is no corrosion and the weight is also reduced.

They are only available in small sizes (up until D110).

The union ends are manufactured in plain ends for solvent socket or thread always according the sizing standards, doing this system appropriate to adapt to other elements or systems. Cepex unions feature an o-ring in order to ensure better unions, so it is not needed the use of PTFE tape between nut and union end (it is only needed in the threaded ends).

They are not recommended when connected to pipe under bending stress.

The union nut should be tightened by hand. Must use a strap wrench for big sizes (D75, D90, D110).

With this type of unions, it is possible to mix several plastic materials.

Cuando hay que unir plásticos, éstos son preferidos a las bridas, ya que no contienen ninguna parte de metal y el diámetro exterior es más reducido.

En contrapartida sólo están disponibles para diámetros pequeños (hasta D110).

Los manguitos de conexión están fabricados en terminaciones lisas de encolado o roscadas, siempre bajo normativas standards, haciendo posible la adaptación a otros componentes (incluso de materiales distintos).

Los enlaces 3 piezas Cepex incorporan junta para asegurar estanqueidad entre los dos manguitos de la unión, por lo que no debe usarse cinta de PTFE entre tuerca y manguito (usar cinta de PTFE solamente en las terminaciones de manguito roscadas). No son recomendables cuando el tubo tenga que estar sometido a fuerza de flexión (debido a posibles desalineaciones).

No es necesario el uso de ninguna herramienta, se rosca con las manos. Usar llave de cinta en diámetros grandes (D75, D90, D110).

Mediante estos enlaces, se pueden combinar diferentes tipos de plásticos.



CONNECTION POSSIBILITIES

POSIBILIDADES DE CONEXIÓN

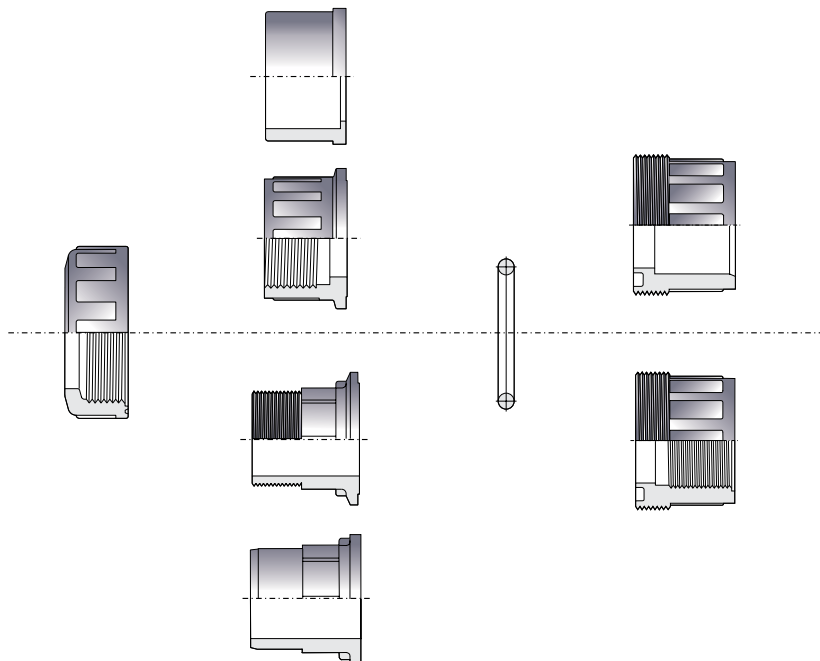

Available standards

Solvent socket: metric, BS, ASTM

Threaded: BSP, NPT

Standards disponibles

Encolar: métrico, BS, ASTM

Roscar: BSP, NPT

Ask for other types of unions or other materials (PP, PE100...)

Consultar otros tipos de conexión o materiales (PP, PE100...)

UP. 50. SF. MA - UNION MA

Union

- Female solvent socket
- ASTM series
- EPDM O-Ring

Enlace 3 piezas

- Encolar hembra
- Serie ASTM
- Anillo tórico en EPDM

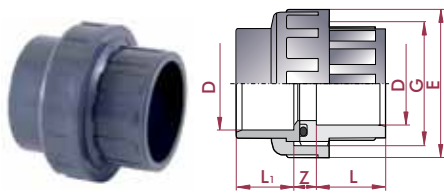

D	DN	PN	REF.	CODE
½"	15	16	05 50 901 MA	25472
¾"	20	16	05 50 902 MA	25473
1"	25	16	05 50 903 MA	25474
1¼"	32	16	05 50 904 MA	25475
1½"	40	16	05 50 905 MA	11937
2"	50	16	05 50 906 MA	15690
2½"	65	10	05 50 907 MA	41528
3"	80	10	05 50 908 MA	41529
4"	100	10	05 50 910 MA	41530

L	Z	G	E	o-ring
16	13	1"	41	20 x 3
19	13	1¼"	52	38 x 3
22	13	1½"	60	33 x 3
26	15	2"	74	41 x 5
31	17	2¼"	80	47 x 5
38	21	2¾"	99	60 x 5
44	21	3½"	120	76 x 5
51	24	4"	138	91 x 5
61	26	5½"	179	110 x 5

UP. 50. FT. MA - UNION MA

Union

- NPT female thread
- ASTM series
- EPDM O-Ring

Enlace 3 piezas

- Roscar hembra NPT
- Serie ASTM
- Anillo tórico en EPDM

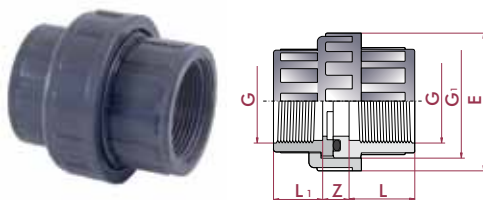

G	DN	PN	REF.	CODE
½"	15	10	05 50 801	25476
¾"	20	10	05 50 802	25477
1"	25	10	05 50 803	25478
1¼"	32	10	05 50 804	25479
1½"	40	10	05 50 805	11811
2"	50	10	05 50 806	15692
2½"	65	10	05 50 807	53120

L	L ₁	Z	G ₁	E	o-ring
16	15	12	1"	41	20,2 x 3,5
19	17	12	1¼"	52	28,2 x 3,5
22	20	14	1½"	60	32,9 x 3,5
26	24	16	2"	74	40,6 x 5,3
31	25	18	2¼"	80	47,0 x 5,3
38	29	20	2¾"	99	59,7 x 5,3
44	34	21	3½"	120	75,6 x 5,3

UP. 50. SFT. MA - UNION MA

Union adaptor

- Female solvent socket x NPT female thread
- ASTM series
- EPDM O-Ring

Enlace 3 piezas

- Encolar hembra x rosca hembra NPT
- Serie ASTM
- Anillo tórico en EPDM

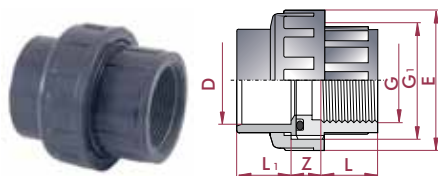

D x G	DN	PN	REF.	CODE
1½" x 1½"	40	16	05 50 935 MA	11810
2" x 2"	50	16	05 50 936 MA	15691

L	Z	G ₁	E	o-ring
31	17	2¼"	90	47 x 5
38	21	2¾"	108	60 x 5

UP. 51. SMT. MA - UNION MA

Union adaptor

- Female solvent socket x NPT male thread
- ASTM series
- EPDM O-Ring

Enlace 3 piezas

- Encolar hembra x rosca macho NPT
- Serie ASTM
- Anillo tórico en EPDM

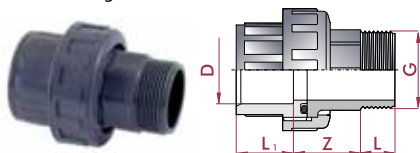

D x G	DN	PN	REF.	CODE
1½" x 1½"	40	16	05 51 935 MA	11813
2" x 2"	50	16	05 51 936 MA	15694

L ₁	L	Z
31	21	48
38	25	62

UP. 51. MFT. MA - UNION MA

Union

- NPT female x male thread
- ASTM series
- EPDM O-Ring

Enlace 3 piezas

- Roscar hembra x macho NPT
- Serie ASTM
- Anillo tórico en EPDM

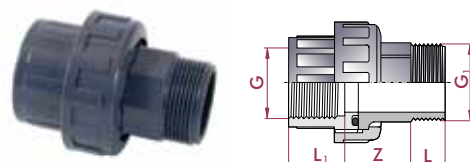

G x G ₁	DN	PN	REF.	CODE
1½" x 1½"	40	10	05 51 805	11812
2" x 2"	50	10	05 51 806	15693

L ₁	L	Z
31	21	48
38	28	62

UP. 50. SF. MA ME - UNION MA ME
Union

- Female solvent socket
- ASTM - Metric Series
- EPDM O-Ring

Enlace 3 piezas

- Encolar hembra
- Serie ASTM - métrica
- Anillo tórico en EPDM

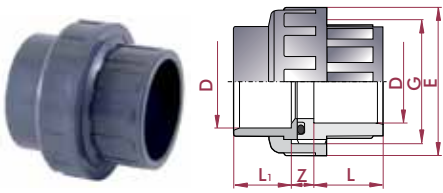

D	DN	PN	REF.	CODE
1" - 32	25	16	05 50 903 MAME	60557
1¼" - 40	32	16	05 50 904 MAME	60558
1½" - 50	40	16	05 50 905 MAME	66441
2" - 63	50	16	05 50 906 MAME	60561
3" - 90	80	10	05 50 908 MAME	60562
4" - 110	100	10	05 50 910 MAME	60563

L	Z	G	E	o-ring
22	13	1½"	60	33 x 3
26	15	2"	74	41 x 5
31	17	2¼"	80	47 x 5
38	21	2¾"	99	60 x 5
51	24	4"	138	91 x 5
61	26	5½"	179	110 x 5

UP. 22. SF. MA - UNION END MA
Union end

- Female solvent socket
- ASTM series

Manguito enlace

- Encolar hembra
- Serie ASTM

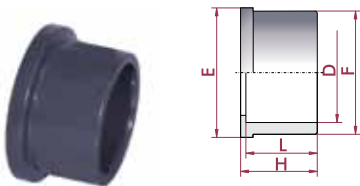

D	DN	PN	REF.	CODE
½"	15	16	05 22 901 MA	22033
¾"	20	16	05 22 902 MA	22034
1"	25	16	05 22 903 MA	22035
1¼"	32	16	05 22 904 MA	22036
1½"	40	16	05 22 905 MA	22037
2"	50	16	05 22 906 MA	22038

L	E	H	F
16	30	19	27
19	39	22	36
22	45	25	41
26	56	29	53
31	63	34	59
38	78	41	74

UP. 22. FT. MA - UNION END MA
Union end

- NPT female thread
- ASTM series

Manguito enlace

- Roscar hembra NPT
- Serie ASTM

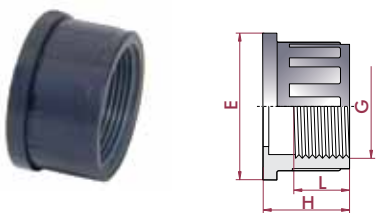

G	DN	PN	REF.	CODE
½"	15	10	05 22 801	22051
¾"	20	10	05 22 802	22052
1"	25	10	05 22 803	22053
1¼"	32	10	05 22 804	22054
1½"	40	10	05 22 805	22055
2"	50	10	05 22 806	22056

L	H	E
15	21	30
17	23	39
20	26	45
24	30	56
25	35	63
29	42	78