

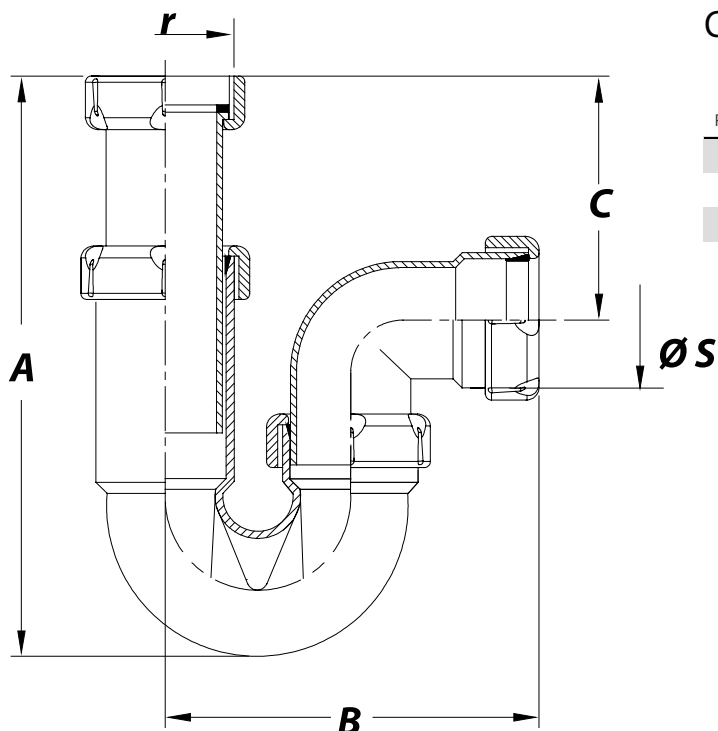

Referencia	Medidas	Carac.	u./caja
006028	1 1/2	EN274	50
006046	1 1/4	-	50
006366	1 1/4 X 1 1/2	EN274	50

Curvo extensible, salida horizontal, racor.

### Cotas



Referencia	A max/min	B max/min	C max/min	r.	ØS
006028	230-170	130-59	120-60	1 1/2"	40
006046	210-163	115-54	115-55	1 1/4"	32
006366	235-175	130-59	125-65	1 1/4"	40

## Documentación



## Instrucciones Tarifas



## Certificados



## Documentos BIM



S-31 - Sifón fregadero

S-31 - Sifón fregadero

Para más información visite la dirección <https://www.jimten.com/es/producto/139/sifon-fregadero/>

